

Eaton EPCT Fire

Touchscreen based electric fire pump controllers



Powering Business Worldwide

Product Description

The EPCT Fire features an advanced, 7" color touchscreen that incorporates both the fire pump controller (FPC) and automatic transfer switch (ATS) functionality into one, intuitive display.

Designed solely with the consumer in mind, the EPCT Fire enables technicians to commission the fire pump controller faster; troubleshooting is made easier and is more effective through the use on-screen history filtering and diagnostic monitoring.

All full-service fire pump controllers can be offered in either full-voltage or reduced voltages starting methods:

- FD/FT20 - Limited service
- FD/FT30 - Across-the-line
- FD/FT40 - Part winding
- FD/FT50 - Primary resistor
- FD/FT60 - Autotransformer
- FD/FT70 - WYE-Delta (Star-Delta) open transition
- FD/FT80 - WYE-Delta (Star-Delta) closed transition
- FD/FT90 - Soft start

Product Features

Touchscreen Display

General

Speed of commissioning, configuration and troubleshooting are more critical to businesses today more than ever. Through the use of a 7" touchscreen, users can easily program all site specific setpoints through an intuitive menu structure, view all critical system information, and troubleshoot quickly and accurately via on-screen diagnostics.

Automatic Transfer Switch Integration

Going away from the multiple screen approach, the EPCT Fire touchscreen integrates both the Fire Pump Controller and Automatic Transfer Switch into one display enabling the user to effectively manage programming and operation from one source.

Commissioning Simplified

The Startup tab features all controller related commissioning tasks such as: Quick Setup, Setup Phase Reversal, Flow Test, Manual/Automatic Starts, and Test Alarms.

UL Type Rating

The touchscreen display has been tested in accordance with UL and achieves a type 4X rating.

Programming Menu

Startup tab

This tab system enables the user to complete all controller related commissioning tasks. Each sub-menu within the Startup tab guides the user through step-by-step, intuitive screens to quickly and effectively complete the startup and commissioning process.

Panel Setup tab

All variables relating to the panel, such as language, date and time, nominal voltage, etc., are located in the Panel Setup tab. For all programming points within the Panel Setup tab, refer to the instruction manual: MN124016EN.

Help tab

The help tab provides end users service contact information from the company that commissioned the unit (if programmed), factory contact information, and a QR code to download the instruction manual onto a mobile device.

Pressure Settings tab

Contains a variety of pressure settings that may be programmed to suit site requirements. Some key settings include: Start Pressure, Stop Pressure, Low Pressure Alarm, High Pressure Alarm, Low Suction Shutdown, Low Foam Shutdown, Pressure Units, and the ability to calibrate the transducer.

Timer Values tab

This tab system contains the programming point for all fire pump controller related timers. These timers are: Minimum Run Time, Acceleration Time, Sequential Start Time, Fail to Start Time, Fail to Stop Time, and Weekly Motor Test Timer.

ATS Settings tab (if equipped)

The ATS Settings tab will only be enabled on units equipped with an automatic transfer switch. Programming points within this tab only pertain to the operation of the transfer switch.

Alarm Setpoints tab

There are seven (7) programmable alarm points within this tab system: Phase Reversal, Phase Failure Alarm Setpoint, Motor Overload Setpoint, Transducer Fail Pump Start, Abort Motor Test on Low Voltage, Voltage Alarm Settings, and Frequency Alarm Settings.

Inputs/Outputs tab

The I/O board is capable of accepting ten (10) custom inputs that can be programmed for seventeen (17) predefined conditions. The output relays can be programmed for sixty-one (61) separate conditions. Additional relays can be added through the use of a single or multiple optional relay boards.

History/Statistics/Diagnostics tab

This tab system allows the customer/technician to view historical data, controller statistics, controller diagnostics, and startup information. To assist, the controller can filter for specific events or between certain dates to speed up troubleshooting.

I/O Board

Power Supply

The redesigned I/O board is equipped with a full voltage power supply capable of accepting voltage inputs between 200-600VAC three phase, or 240VAC single phase.

Customer Input Connections

Connection terminals are provided at the top of the I/O board for external customer connections that can be programmed through the touchscreen display.

Output Relays

The I/O board features four (4), 250VAC, 8A, 2 Form-C relays designated for the following: Common Alarm, Power/Phase Failure, Phase Reversal, and Pump Run. Each relay socket has a surface mount LED to indicate the relay's coil status.

Optional Boards

The controller can accept up to four (4) additional option boards: optional relay board, MODBUS communication board, secondary 4-20mA device board, and an alarm board. The controller has provisions to allow future optional boards to be added with plug-and-play functionality.

Other Components

Drain Valve Solenoid

All full-service EPCT Fire controllers are equipped with a drain valve solenoid used for manual or automatic motor tests.

External USB Port

The USB port allows the user to download historical messages, statistics, diagnostic information, startup file, and current controller configuration to any USB device with FAT16 or FAT 32 formatting.

Enclosures

The EPCT Fire controllers come standard with UL type 2 (drip-proof) enclosures. Optional enclosures are available and include: type 3, 3R, 4, 4X, and 12.

Display Screens

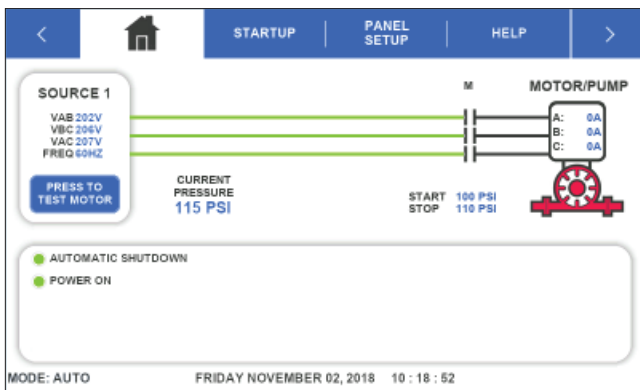

Home tab - without ATS

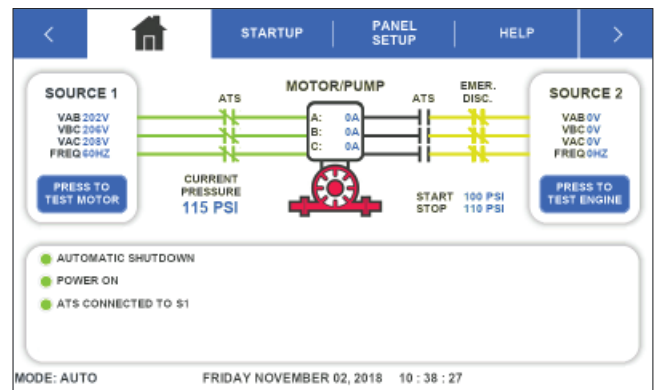

Home tab - with ATS



Common Alarm Settings

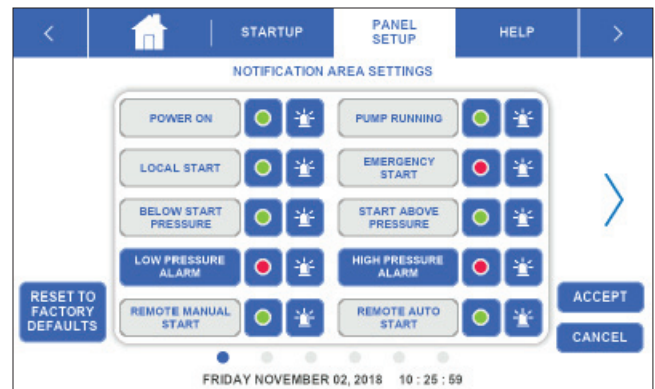

Notification Area Settings



Message History

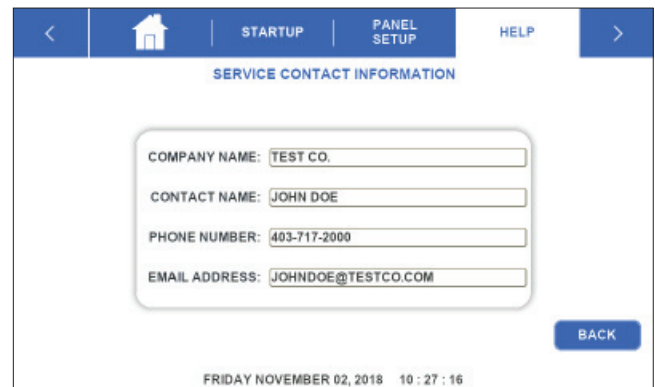

Customer Service Contact

Emergency Start Operator

A mechanically operated emergency start handle (ESH) will mechanically activate the motor contactor(s) independently from any electrical control circuits.

Standards & Certifications

All EPCT Fire full-service, electric fire pump controllers meet or exceed the requirements of Underwriters Laboratories and Underwriters Laboratories Canada [UL218 and UL1008], Factory Mutual, the Canadian Standards Association, New York City building code, CE mark, U.B.C./C.B.C. seismic requirements, and are built to the latest edition of NFPA 20 standards. The EPCT Fire electric fire pump controllers are suitable for use as service entrance equipment - does not meet CEC requirements for Canada.

Quick Specification Overview

Starting Conditions					Withstand Ratings		
Starting Method	Starting Voltage	Starting Current	Starting Torque	Motor Connections	Voltage	HP	Short Circuit Withstand Rating
FD/FT20 Limited Service	Full	600%	100%	2 (SP) or 3	200-208V	5-30	25,000
					220-240V	5-30	25,000
					380-415V	5-30	25,000
					440-480V	5-30	25,000
					575-600V	5-30	18,000
					240V (SP)	5-15	10,000
FD/FT30 Across-the-Line	Full	600%	100%	3	200-208V	5-150	100,000
					220-240V	5-200	100,000
					380-415V	5-300	100,000
					440-480V	5-400	100,000
					575-600V	5-500	25,000
FD/FT40 Part Winding	Reduced	65%	50%	6	200-208V	5-250	100,000
					220-240V	5-300	100,000
					380-415V	5-500	100,000
					440-480V	5-600	100,000
					575-600V	5-700	25,000
FD/FT50 Primary Resistor	Reduced	50%	42%	3	200-208V	5-150	100,000
					220-240V	5-200	100,000
					380-415V	5-300	100,000
					440-480V	5-400	100,000
					575-600V	5-500	25,000
FD/FT60 Autotransformer	Reduced	45%	42%	3	200-208V	5-150	100,000
					220-240V	5-200	100,000
					380-415V	5-300	100,000
					440-480V	5-400	100,000
					575-600V	5-500	25,000
FD/FT70 WYE-Delta (Star-Delta) Open Transition	Reduced	33%	33%	6	200-208V	5-250	100,000
					220-240V	5-300	100,000
					380-415V	5-500	100,000
					440-480V	5-600	100,000
					575-600V	5-700	25,000
FD/FT80 WYE-Delta (Star- Delta) Closed Transition	Reduced	33%	33%	6	200-208V	5-250	100,000
					220-240V	5-300	100,000
					380-415V	5-500	100,000
					440-480V	5-600	100,000
					575-600V	5-700	25,000
FD/FT90 Soft Start	Reduced	Adjustable	Adjustable	3	200-208V	5-150	100,000
					220-240V	5-200	100,000
					380-415V	5-300	100,000
					440-480V	5-400	100,000
					575-600V	5-500	25,000

Eaton
1000 Eaton Boulevard
Cleveland, OH 44122
United States
Eaton.com

Electrical Sector
Canadian Operations
5050 Mainway
Burlington, ON L7L 5Z1
Canada
EatonCanada.ca
CHFire.com

© 2018 Eaton
All Rights Reserved
Printed in Canada
Publication No. BR124053EN / 001
January 2018

Eaton is a registered trademark.

All other trademarks are property
of their respective owners.

Follow us on social media to get the
latest product and support information.



Powering Business Worldwide

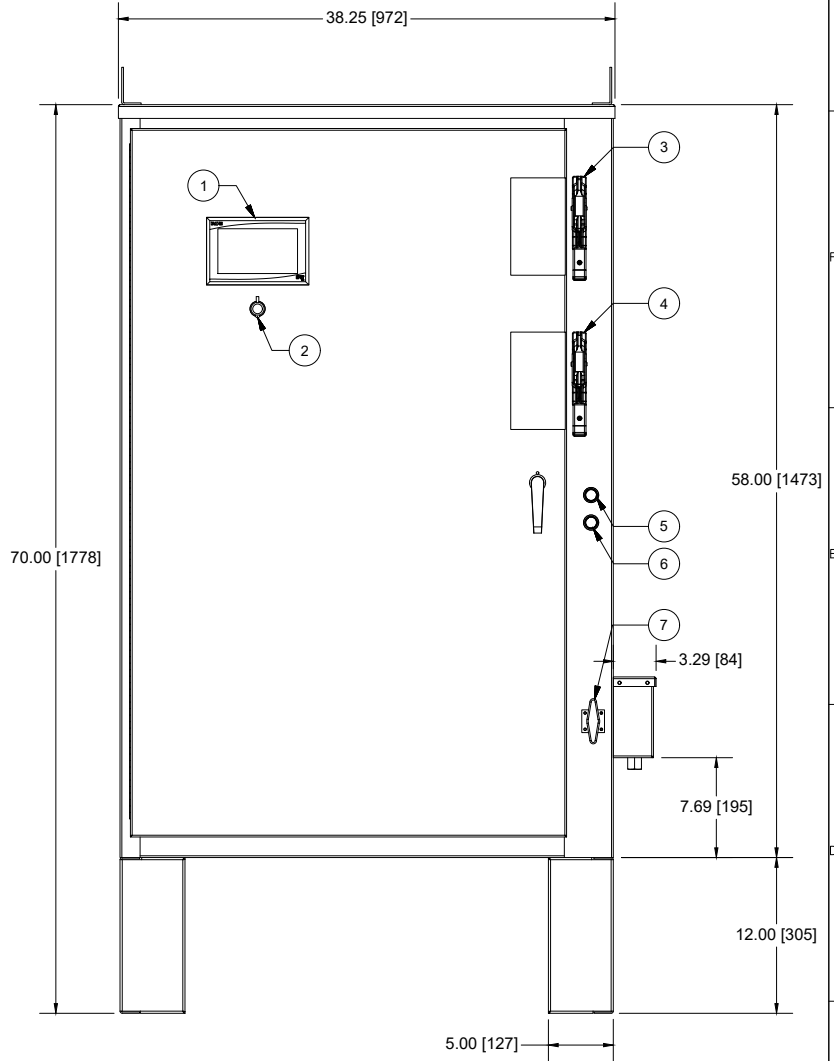
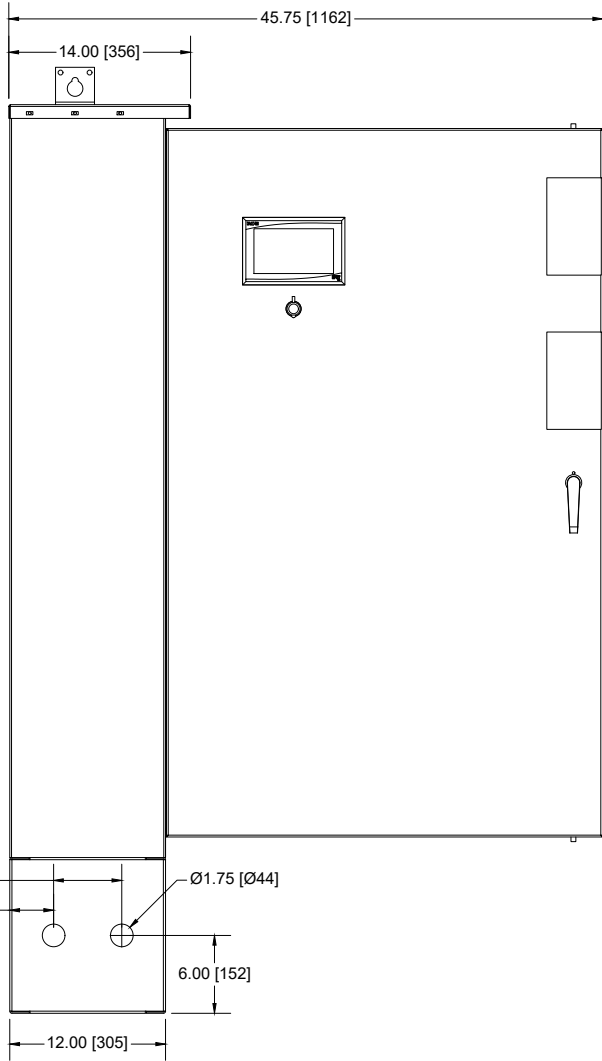

- 1 - EPCT TOUCHSCREEN
- 2 - EXTERNAL USB PORT
- 3 - SOURCE 1 POWER SWITCH
- 4 - SOURCE 2 POWER SWITCH
- 5 - START PUSHBUTTON
- 6 - STOP PUSHBUTTON
- 7 - MSH (EMERGENCY START HANDLE)
- 8 - RECOMMENDED CABLE ACCESS (BOTTOM ONLY)

NOTES:
 1 - DIMENSIONS: in [mm]
 2 - ALL ENCLOSURES FINISHED IN RED
 3 - STANDARD ENCLOSURE: TYPE (NEMA) 2

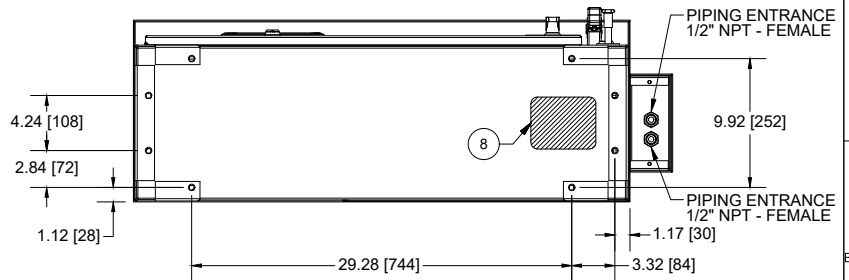

Motor HP	Line voltage	Withstand rating			Approximate weight Lbs. (Kg)
		Standard	Intermediate	High	
5 - 40	200 - 208V	100,000	150,000	200,000	405 (183)
5 - 50	220 - 240V				
5 - 75	380 - 415V				
5 - 100	440 - 480V				
5 - 100	550 - 600V	25,000	100,000		

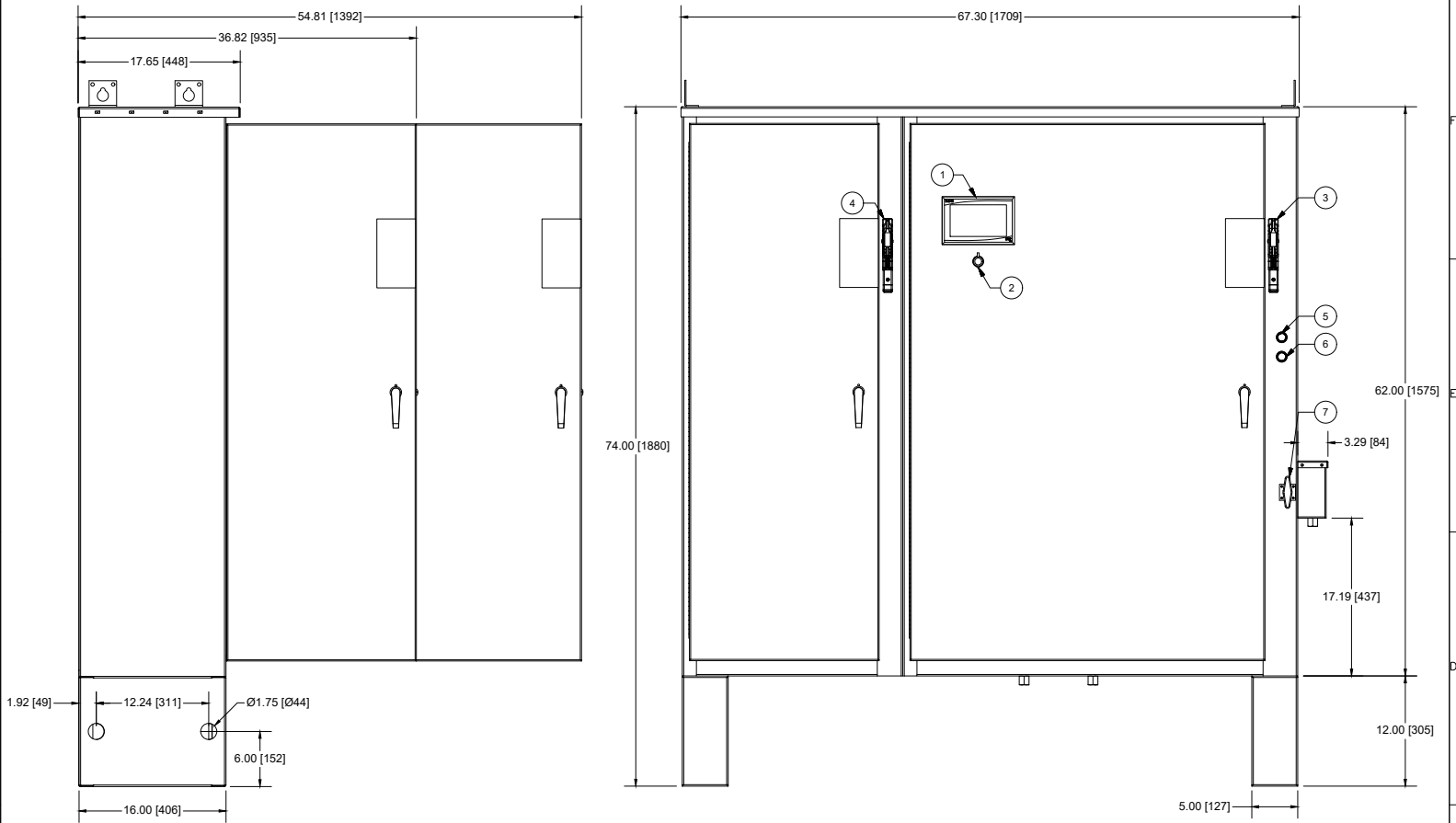

- 1 - EPCT TOUCHSCREEN
- 2 - EXTERNAL USB PORT
- 3 - SOURCE 1 MAIN POWER SWITCH
- 4 - SOURCE 2 MAIN POWER SWITCH
- 5 - START PUSHBUTTON
- 6 - STOP PUSHBUTTON
- 7 - MSH (EMERGENCY START HANDLE)
- 8 - RECOMMENDED CABLE ACCESS (BOTTOM ONLY)

NOTES:
 1 - DIMENSIONS: in [mm]
 2 - ALL ENCLOSURES FINISHED IN RED
 3 - STANDARD ENCLOSURE: TYPE (NEMA) 2

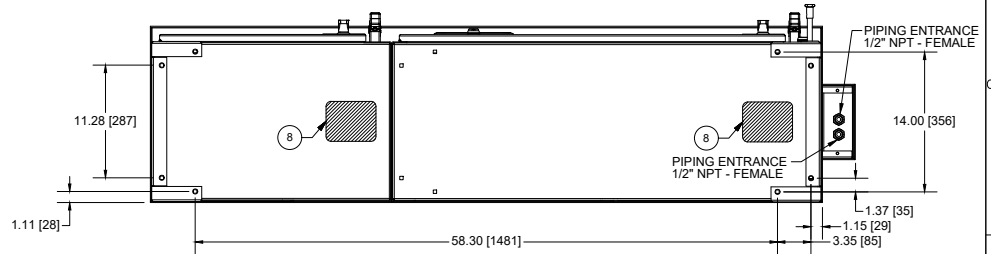

Motor HP	Line voltage	Withstand rating			Approximate weight Lbs. (Kg)
		Standard	Intermediate	High	
50 - 150	200 - 208V	100,000	150,000	200,000	760 (344)
60 - 200	220 - 240V				
100 - 300	380 - 415V				
125 - 400	440 - 480V				
125 - 400	550 - 600V	25,000	100,000		

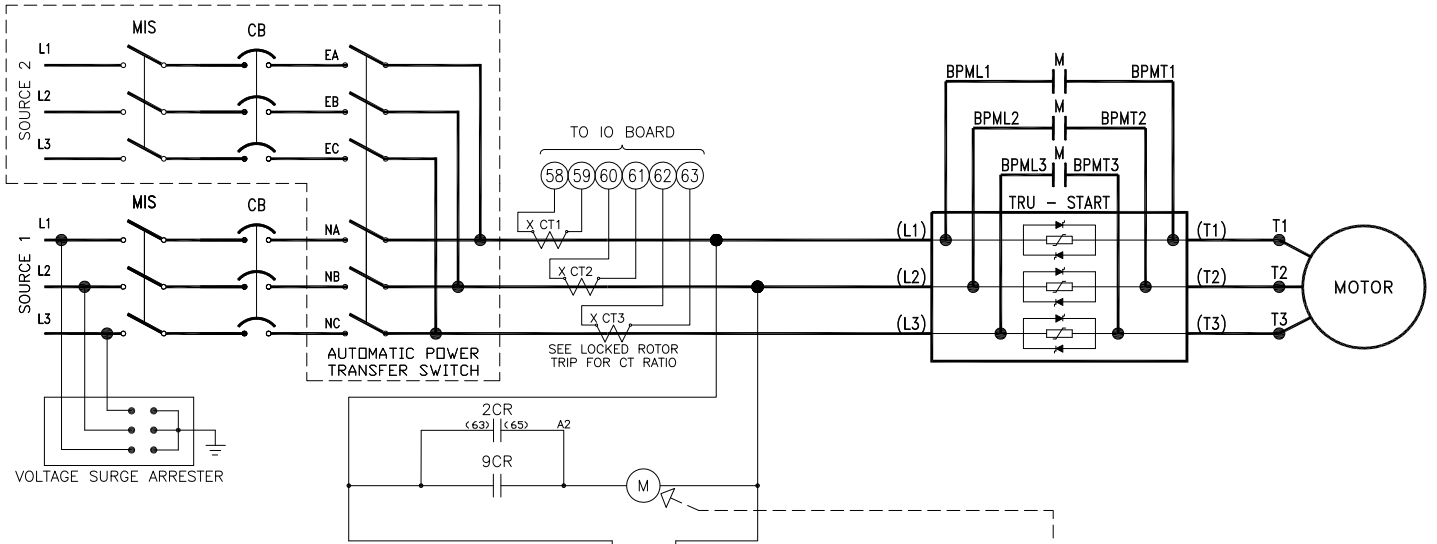

NOTES:
 1. POWER/PHASE FAILURE AND COMMON ALARM RELAYS ARE ENERGIZED UNDER NORMAL CONDITIONS.
 2. ALL RELAY CONTACTS ARE SHOWN IN NO POWER CONDITION.

LEGEND:
 9CR - BYPASS RELAY
 CB - CIRCUIT BREAKER
 CT - CURRENT TRANSFORMER
 M - RUN CONTACTOR
 MIS - MAIN ISOLATING SWITCH
 MSH - MANUAL START HANDLE
 (EMERGENCY) MICRO SWITCH

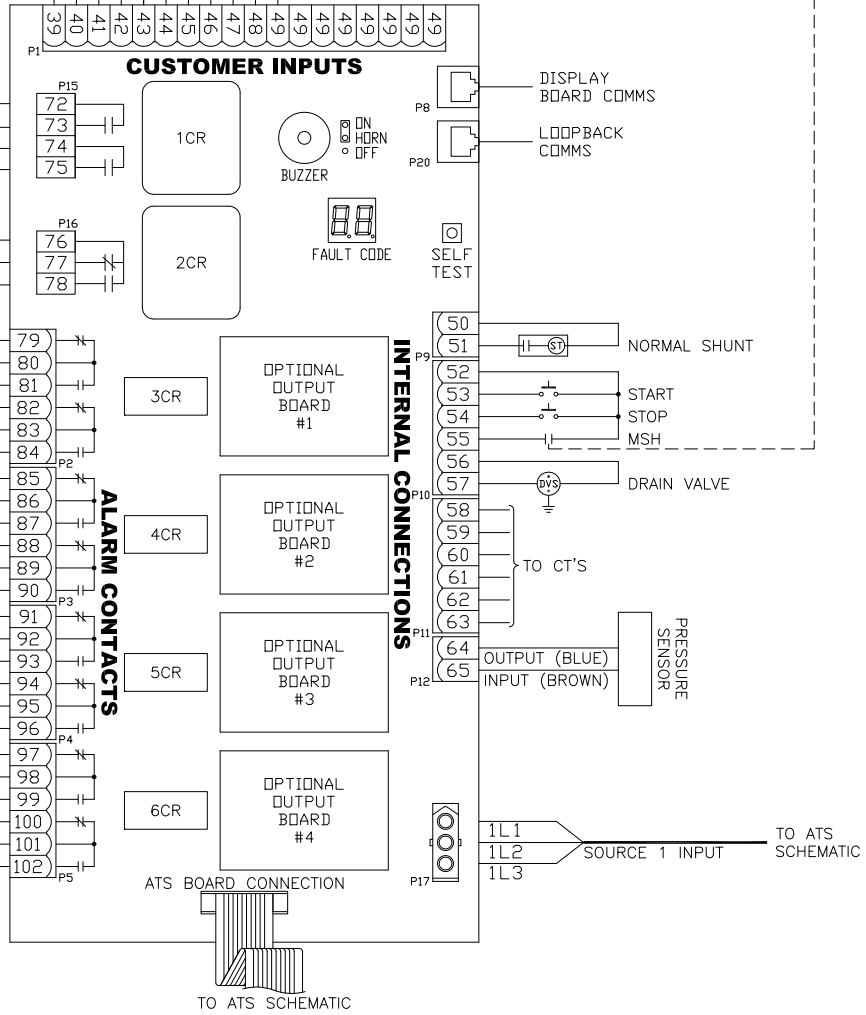
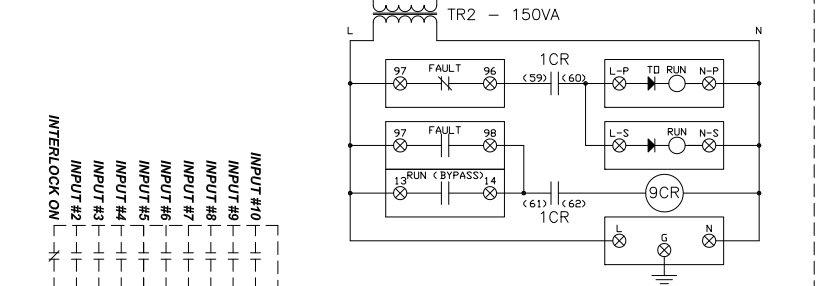

THE INFORMATION ON THIS DOCUMENT IS CREATED BY EATON. IT IS DISCLOSED IN CONFIDENCE AND IS ONLY TO BE USED FOR THE PURPOSE OF WHICH IT IS SUPPLIED.
 LES RENSEIGNEMENTS C-DESSUS ONT ÉTÉ ÉLABORÉS PAR EATON, ILS VOUS SONT DIVULGUÉS EN TOUTE CONFIDANCE ET LEUR UTILISATION SE LIMITE AUX SEULES FINS POUR LESQUELLES ILS VOUS SONT TRANSMIS.

REVISION	DATE	DRAWING NO.
001	09/25/18	CE16492H18

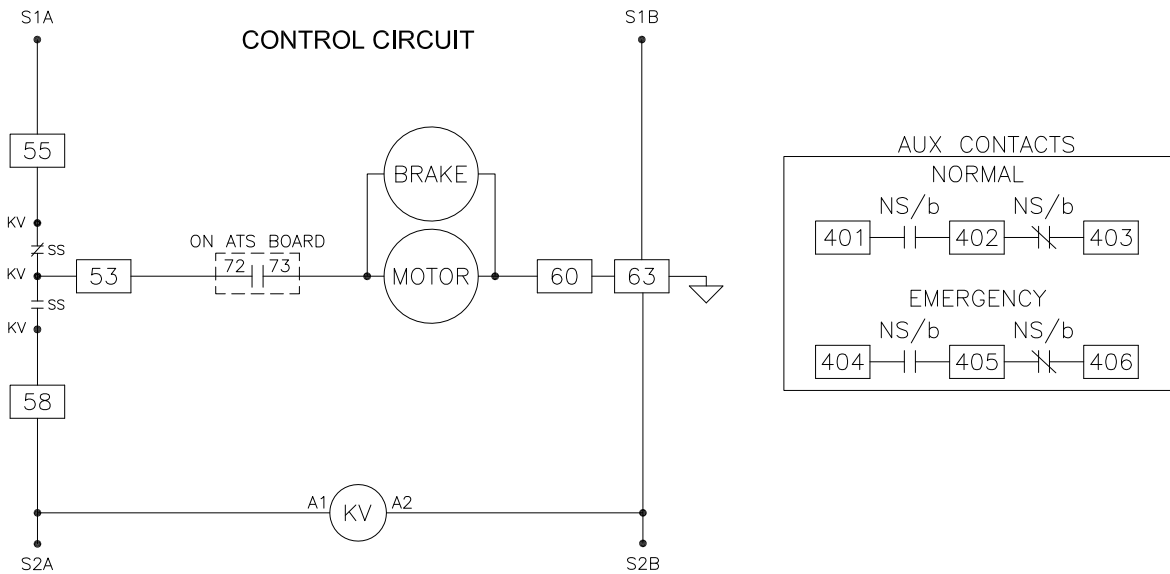
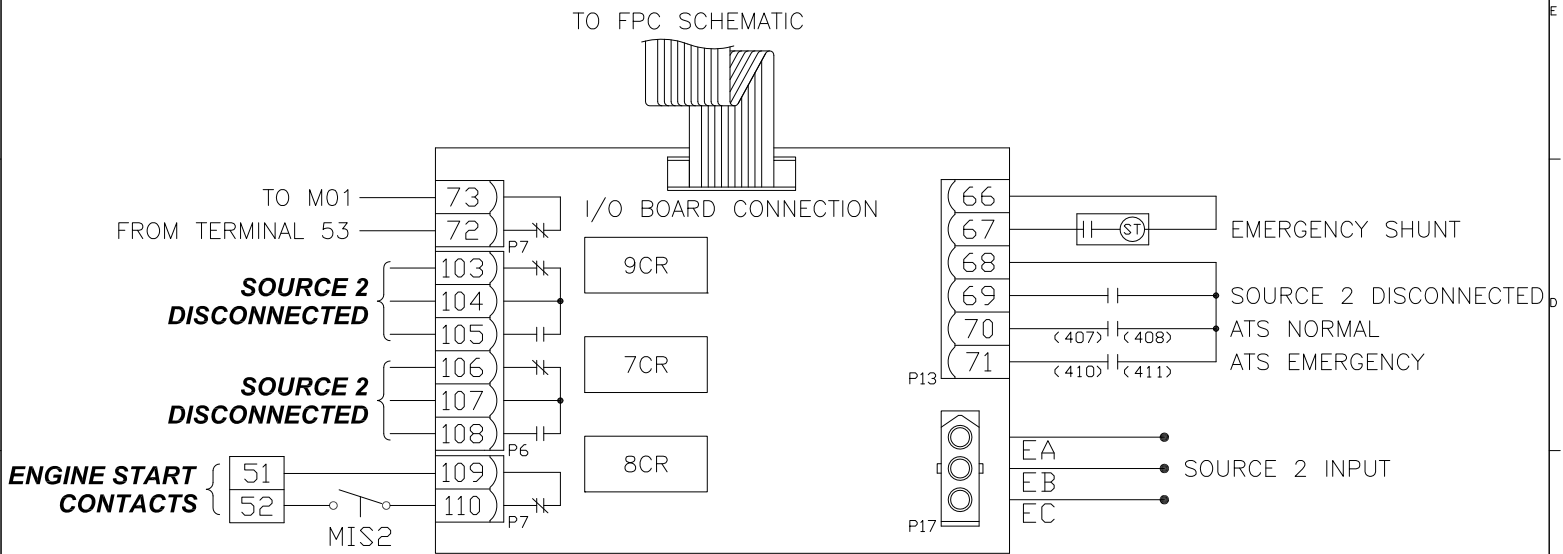
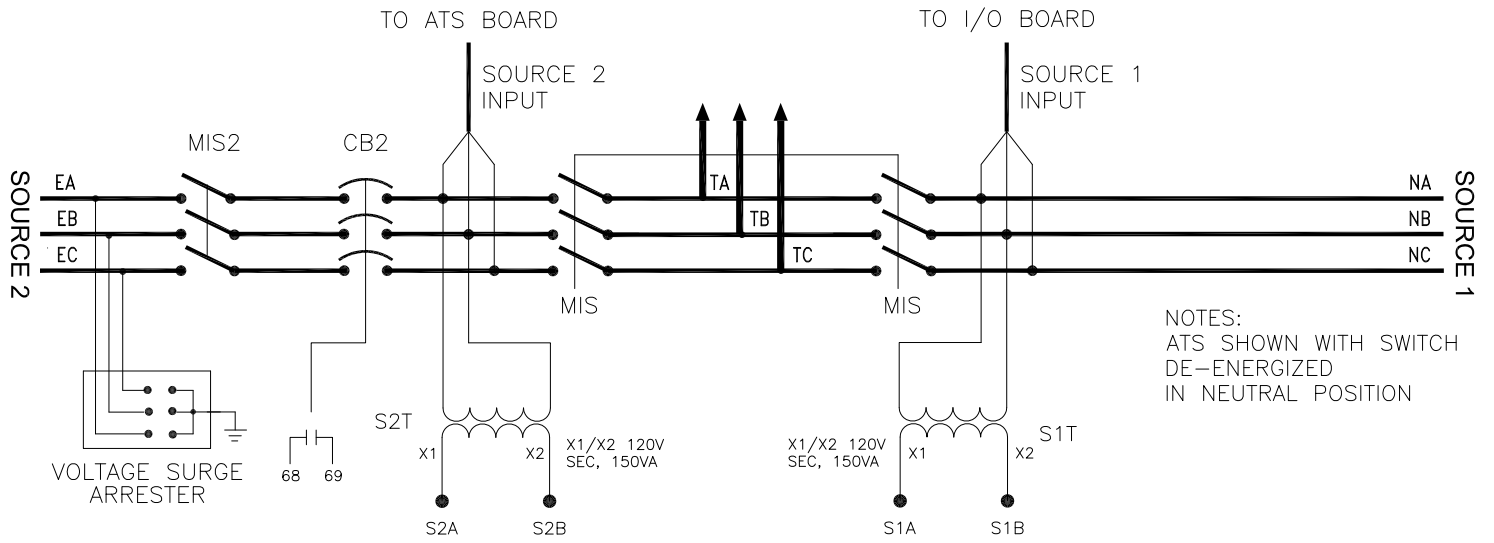

Line Terminals Connections

Max HP	Line Voltage					Line Lugs (QTY.) & Cable Size per Ø	Service Ground Lugs (QTY.) & Cable Size per Ø
	200-208	220-240	380-415	440-480	575-600		
25	30	40	60	75	(1) #14 - 1/0 (CU/AL)	(1) #14 - 2/0 (CU/AL)	
40	50	75	100	100	(1) #4 - 4/0 (CU)	(1) #4 - 350MCM (CU/AL)	
75	75	150	200	200	(1) #3 - 350MCM (CU/AL)	(1) #4 - 350MCM (CU/AL)	
100	125	200	250	300	(2) 3/0 - 350MCM (CU/AL)	(2) 1/0 - 750MCM (CU/AL)	
150	200	300	400	500	(2) 250 - 350MCM (CU/AL)	(2) 1/0 - 750MCM (CU/AL)	

Load Terminals Connections

Max HP	Line Voltage					Single Run Cable Sizes	Double Run Cable Sizes
	200-208	220-240	380-415	440-480	575-600		
10	10	15	20	25	#14 - #8 (CU/AL)	#14 - #8 (CU/AL)	
20	25	30	50	60	#14 - #1 (CU/AL)	#14 - #2 (CU/AL)	
40	60	75	125	100	#8 - 3/0 (CU/AL)	#8 - 2/0 (CU/AL)	
75	100	150	200	200	#2 - 750MCM (CU/AL)	1/0 - 250MCM (CU/AL)	
150	200	300	400	500	1/0 - 500MCM (CU/AL)	1/0 - 500MCM (CU/AL)	

For ambient temperatures exceeding 30C (86F), the temperature rating of motor conductors is recommended to be a minimum of 90C (194F)

For proper cable size, refer to the National Electric Code (NEC - NFPA70)

CONTROLLER CONNECTIONS

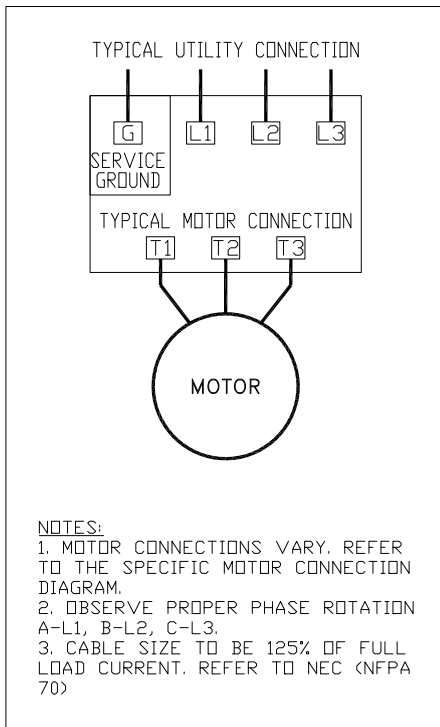

ALARM CONTACTS

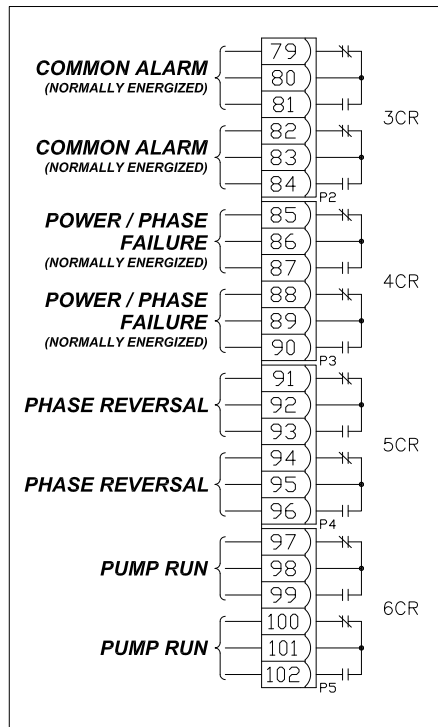

CUSTOMER INPUTS

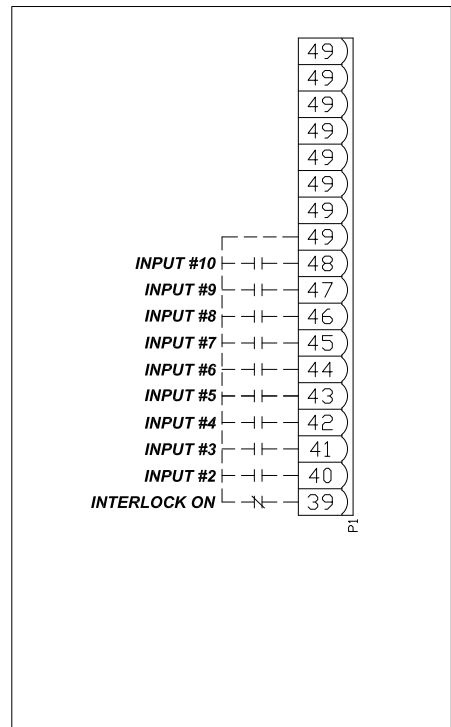

TRANSFER SWITCH CONNECTIONS (IF EQUIPPED)

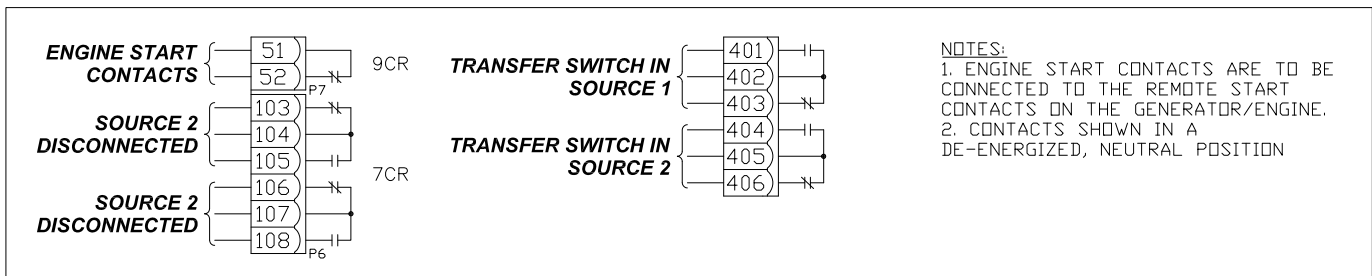

EPCT Fire option selection matrix

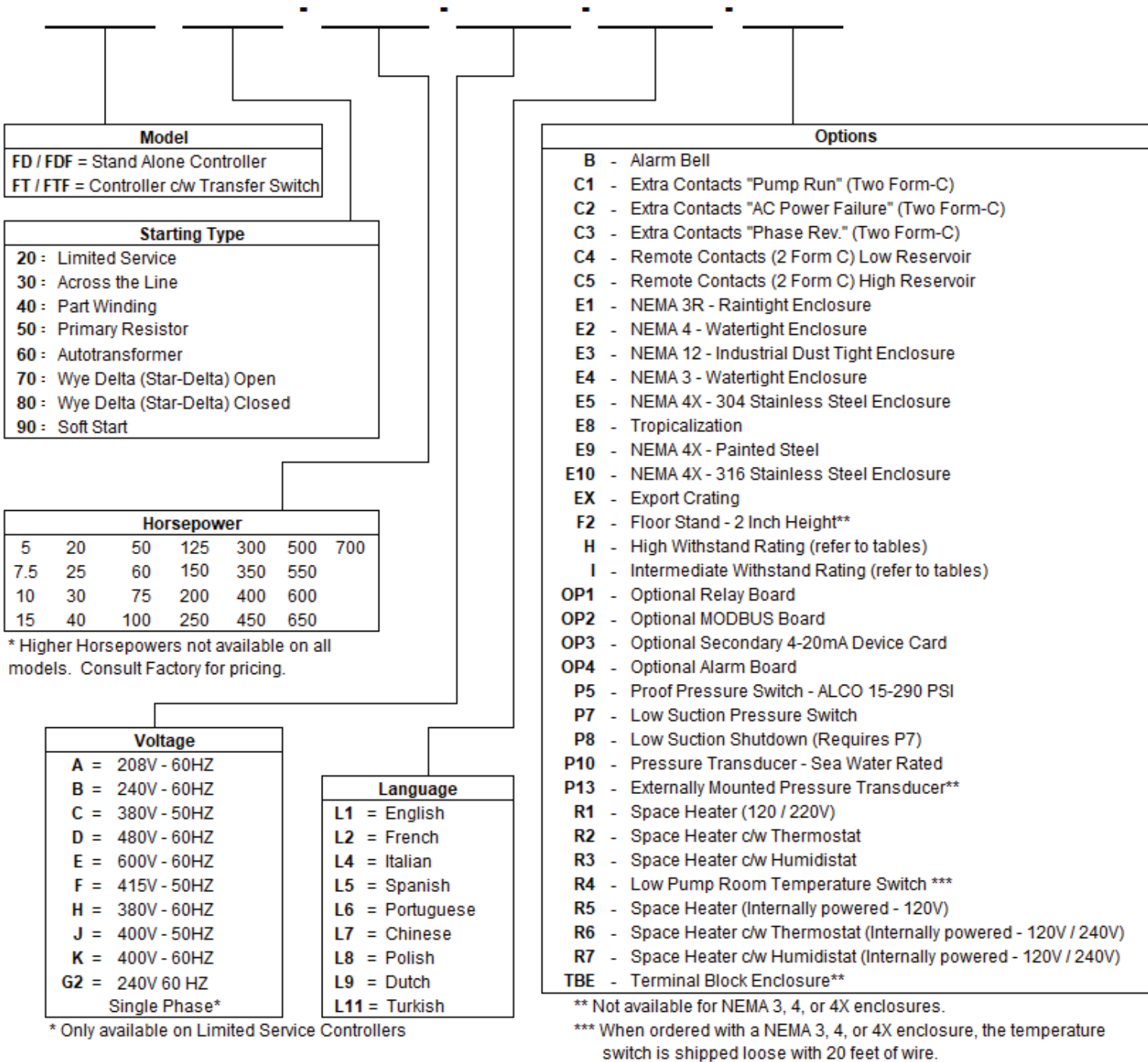

EPCT Fire electric fire pump controllers

Typical specifications

1. Approvals

- A. The Fire Pump Controller shall meet the requirements of the latest edition of NFPA 20 and shall be listed by [Underwriters Laboratories (UL)] and approved by [Factory Mutual Research (FM)] [Canadian Standards Association (CSA)] [New York Department of Buildings (NYSB)] and carry the CE marking for fire pump service.

2. Starting type

- A. The controller shall be of the combined manual and automatic type designed for [Full Voltage Starting] [Part Winding Starting] [Primary Resistor Starting] [Autotransformer Starting] [Wye-Delta (Star-Delta) Open Transition Starting] [Wye-Delta (Star-Delta) Closed Transition Starting] [Solid State Soft Start Starting]

3. Ratings

- A. The Controller shall have a withstand rating of 100,000 RMS symmetrical amperes @ [208V] [240V] [380V] [400V] [415V] [480V] [25,000 @ 600VAC].
- B. Temperature:
4 to +50 deg. C (39 to +122 deg. F)

4. Construction

- A. The controller shall include a motor rated combination isolating switch and circuit breaker, mechanically interlocked and operated with a single externally mounted handle.
- B. The isolating switch shall be rated to disconnect the motor load.
- C. The isolating switch/circuit breaker combination shall be mechanically interlocked such that the enclosure door cannot be opened when the handle is in the on position except by a tool operated defeater mechanism.
- D. The controller manufacturer shall manufacture the contactor, isolating switch, circuit breaker, pushbuttons, and enclosures. Brand-labeled components will not be accepted.

5. Enclosure

- A. The controller shall be housed in a Type 2 (IEC IP11) drip-proof, powder baked finish, freestanding enclosure.

B. Optional enclosures:

1. Type 3R (IEC IP14) rain-tight enclosure
2. Type 3 (IEC IP55) water-resistant enclosure
3. Type 4 (IEC IP66) watertight enclosure
4. Type 4X (IEC IP66) watertight 304 stainless steel enclosure
5. Type 4X (IEC IP66) watertight 316 stainless steel enclosure
6. Type 4X (IEC IP66) watertight corrosion resistant enclosure
7. Type 12 (IEC IP52) dust-tight enclosure

6. Microprocessor control

- A. The controller shall come complete with a 7", 800x480, color touchscreen. The touchscreen shall be type 4X rated.
 1. Home tab capable of displaying system pressure, three phase voltage and amperage readings for both sources, system frequency, date, and time, configurable notifications in the notification area, displaying current start and stop set points, and visual representation of the transfer switch position, source 2 disconnect handle, and contactor.
 2. Virtual buttons to manually test the pump motor and/or the backup power supply engine.
 3. Controller statistics screen, including:
 - A. Total Powered Time
 - B. Total Motor Run Time
 - C. Last Motor Run Time
 - D. Calls to Start
 - E. Motor Starts
 - F. Maximum Starting Current A
 - G. Maximum Starting Current B
 - H. Maximum Starting Current C
 - I. Maximum Run Current A
 - J. Maximum Run Current B
 - K. Maximum Run Current C
 - L. Last LR Current A
 - M. Last LR Current B
 - N. Last LR Current C
 - O. Minimum System Pressure
 - P. Maximum System Pressure
 - Q. Minimum S1 Voltage AB



Powering Business Worldwide

Fire pump controllers Features

- R. Minimum S1 Voltage BC
 - S. Minimum S1 Voltage CA
 - T. Maximum S1 Voltage AB
 - U. Maximum S1 Voltage BC
 - V. Maximum S1 Voltage CA
 - W. Minimum S2 Voltage AB
 - X. Minimum S2 Voltage BC
 - Y. Minimum S2 Voltage CA
 - Z. Maximum S2 Voltage AB
 - AA. Maximum S2 Voltage BC
 - AB. Maximum S2 Voltage CA
 - AC. Minimum S1 Frequency
 - AD. Maximum S1 Frequency
 - AE. Minimum S2 Frequency
 - AF. Maximum S2 Frequency
 - AG. Last System Startup
 - AH. Last Motor Start
 - AI. Last Low Pressure Start
 - AJ. Last Locked Rotor Trip
 - AK. Last S1 Phase Failure
 - AL. Last S2 Phase Failure
 - AM. Last S1 Phase Reversal
 - AN. Last S2 Phase Reversal
 - AO. Last S1 Undervoltage
 - AP. Last S1 Overvoltage
 - AQ. Last S2 Undervoltage
 - AR. Last S2 Overvoltage
 - AS. Last S1 Under Frequency
 - AT. Last S1 Over Frequency
 - AU. Last S2 Under Frequency
 - AV. Last S2 Over Frequency
 - AW. Last Generator Start
 - AX. Last Generator Stop
 - AY. Last transfer to S1
 - AZ. Last transfer to S2
 - BA. Last S2 Disconnect
4. Controller diagnostics screen, including:
- A. Controller Serial Number
 - B. Logic Board Firmware Version
 - C. I/O Board Firmware Version
 - D. I/O Board Supply Voltage
 - E. I/O Board Communication
 - F. CT1 Secondary Amperage
 - G. CT2 Secondary Amperage
 - H. CT3 Secondary Amperage
 - I. Transducer Input Voltage
 - J. Transducer Output Current
 - K. Transducer Setpoint Current 2
 - L. Transducer Setpoint Current 1
- M. All Input Status (Open or Closed) (Can be selected to override for one minute and manually change the state of the input)
 - N. All Output Relay Status (Energized or De-energized) (Can be selected to override for one minute and manually energize or de-energize the relay)
 - O. Test the display board's communication.
5. Archive message screen that will display up to 65,000 alarms/messages stored in the controllers' memory
- B. The microprocessor logic board shall be available with a USB port for transference of message history, controller status, diagnostics, startup and statistic files and the ability to update firmware.
 - C. A Fail-to-Start alarm shall occur if the motor controller sees less than 20% of the motor full load amps after an adjustable time delay of 1-99 seconds.
 - D. Locked rotor protection shall be provided. After a trip condition and restoration of power, the display shall indicate the voltage, current, and date and time at the moment that the controller tripped.
 - E. A sequential start timer and weekly test timer shall be provided as standard.
 - F. A restart time delay of one (1) second shall be provided to allow the residual voltage of the motor to decay prior to re-starting the motor. In the event that the pump motor continues to run after a request to stop, then the controller must display a fail to stop message to indicate this condition.
 - G. Overvoltage (0-100%) and undervoltage (0-100%) sensing and alarming shall be provided as standard.
 - H. The controller shall be supplied with interlock and shutdown circuits as standard. A green LED in the notification area shall indicate an interlock on condition.
 - I. Where shutdown of the pump(s) due to low suction pressure is required, it shall be accomplished without the addition of a separate panel or enclosure. The display shall indicate low suction shutdown. Resetting of the condition shall be automatic or manual as selected by the user.
7. Programming Menu
- A. The programming menu shall have the ability to enable an entry password.
 - B. The controller shall have nine (9) languages as a standard: English, French, Spanish, Portuguese, Turkish, Italian, Dutch, Chinese, and Polish.
 - C. The programming menu shall be grouped into ten (10) tabs as follows:
 - 1. Home
 - 2. Startup
 - 3. Panel Setup
 - 4. Help
 - 5. Pressure Settings
 - 6. Timer Values

7. ATS Settings
8. Alarm Setpoints
9. Inputs/Outputs
10. History/Statistics/Diagnostics

8. Pressure sensor

- A. A solid-state 4-20mA pressure sensor shall be provided. The pressure Start and Stop points shall be adjustable in increments of one (1) PSI.

9. Custom inputs/outputs

- A. The controller shall come standard with ten (10) programmable inputs, four (4) programmed outputs with the ability to add up to another sixteen (16) outputs via optional relay boards.
- B. The user shall be able to program the inputs/outputs through the main programming menu.
- C. The inputs shall be selectable based on the following criteria:
 1. User selected message or seventeen (17) predetermined messages
 2. Link to a future relay and/or LED indicator
 3. Alarm latched until reset
 4. Normally open or closed input
 5. On and/or off-delay timer
- D. The future relays shall be selectable based on the following criteria:
 1. Output based on a minimum of sixty-one (61) predetermined alarms, controller status or a custom input
 2. Latched until reset
 3. Energized under normal conditions
 4. On and/or off delay timer on the output

10. Alarm relays

- A. All relays shall be soldered on the PCB. An LED on the relay panel shall indicate the energized state of the relay. All relay contacts shall be rated @ 8A, 277VAC/30VDC. Two (2) sets of Form-C contacts shall be provided for each of the following:
 1. Common Alarm
 2. Power/Phase Failure
 3. Phase Reversal
 4. Pump Run
- B. The Common Alarm and Power/Phase Failure relays shall be energized under normal conditions.

11. Audible alarm buzzer

An audible alarm buzzer, capable of being heard

while the motor is operating, shall operate if Fail to Start, Hardware Malfunction or any Common Alarm condition exists.

12. Manufacturer

- A. The controller shall be of the EPCT Fire type as manufactured by Eaton Corporation.