

EPCT Fire series Fire Pump Controller



DISCLAIMER OF WARRANTIES AND LIMITATION OF LIABILITY

The information, recommendations, descriptions and safety notations in this document are based on Eaton Corporation's ("Eaton") experience and judgment and may not cover all contingencies. If further information is required, an Eaton sales office should be consulted. Sale of the product shown in this literature is subject to the terms and conditions outlined in appropriate Eaton selling policies or other contractual agreement between Eaton and the purchaser.

THERE ARE NO UNDERSTANDINGS, AGREEMENTS, WARRANTIES, EXPRESSED OR IMPLIED, INCLUDING WARRANTIES OF FITNESS FOR A PARTICULAR PURPOSE OR MERCHANTABILITY, OTHER THAN THOSE SPECIFICALLY SET OUT IN ANY EXISTING CONTRACT BETWEEN THE PARTIES. ANY SUCH CONTRACT STATES THE ENTIRE OBLIGATION OF EATON. THE CONTENTS OF THIS DOCUMENT SHALL NOT BECOME PART OF OR MODIFY ANY CONTRACT BETWEEN THE PARTIES.

In no event will Eaton be responsible to the purchaser or user in contract, in tort (including negligence), strict liability or otherwise for any special, indirect, incidental or consequential damage or loss whatsoever, including but not limited to damage or loss of use of equipment, plant or power system, cost of capital, loss of power, additional expenses in the use of existing power facilities, or claims against the purchaser or user by its customers resulting from the use of the information, recommendations and descriptions contained herein. The information contained in this manual is subject to change without notice.

Index

1.0	Introduction	1
1.1	Safety.....	1
1.2	Warranty.....	1
1.3	Safety precautions.....	1
1.4	Product overview.....	1
2.0	Installation and electrical connections	2
2.1	Mounting.....	2
2.2	Pressure switch connections.....	2
2.3	Electrical connections.....	2
2.3.1	Wire sizes.....	2
2.3.2	Electrical checkout instructions.....	2
3.0	Hardware description	4
3.1	General.....	4
3.2	Display board.....	4
3.2.1	Memory.....	4
3.2.2	Battery backup.....	4
3.2.3	Color touchscreen specifications.....	4
3.2.4	USB port.....	4
3.3	Power I/O board.....	4
3.4	ATS board (if equipped).....	4
3.5	Main isolating switch/circuit interrupter.....	4
3.6	Contactors.....	4
3.7	External pushbuttons.....	5
3.8	Transfer switch components.....	5
4.0	Operation	6
4.1	General.....	6
4.2	Welcome screen.....	6
4.2.1	Welcome screen and home screen graphics.....	6
4.2.1.1	<i>Welcome screen</i>	6
4.2.1.2	<i>Home Tab without an ATS</i>	7
4.2.1.3	<i>Home screen of a controller without an ATS (motor running)</i>	8
4.3	Automatic start / stop.....	8
4.3.1	Manual start sequence.....	8
4.3.2	Automatic start sequence.....	9
4.4	Control inputs.....	9
4.4.1	Control input descriptions.....	9
4.4.1.1	<i>Remote manual start</i>	9
4.4.1.2	<i>Remote manual stop</i>	9
4.4.1.3	<i>Remote manual start/stop</i>	9
4.4.1.4	<i>Remote auto start</i>	9
4.4.1.5	<i>Deluge valve start</i>	9

Index

- 4.4.1.6. Low suction.....9
- 4.4.1.7. Low foam level.....9
- 4.4.1.8. Proof pressure switch.....9
- 4.4.1.9. Low room temperature.....9
- 4.4.1.10. High room temperature.....9
- 4.4.1.11. Interlock.....10
- 4.4.1.12. Low reservoir.....10
- 4.4.1.13. High reservoir.....10
- 4.4.1.14. Go to source 1.....10
- 4.4.1.15. Go To Source 2.....10
- 4.4.1.16. Enable Sequential Start.....10
- 4.5 Output relays.....10
 - 4.5.1 Startup (1CR).....10
 - 4.5.2 Acceleration (2CR).....10
 - 4.5.3 Common alarm (3CR).....10
 - 4.5.4 Power / phase failure (4CR).....10
 - 4.5.5 Phase reversal (5CR).....10
 - 4.5.6 Pump run (6CR).....10
- 5.0 Programming**.....11
 - 5.1 Introduction.....11
 - 5.2 Navigation.....11
 - 5.3 Startup tab.....12
 - 5.3.1 Quick setup.....12
 - 5.3.2 Setup phase reversal.....12
 - 5.3.3 Flow test.....13
 - 5.3.4 Manual/Automatic start.....13
 - 5.3.5 Test alarm.....13
 - 5.3.6 USB download.....13
 - 5.4 Panel setup tab.....13
 - 5.4.1 Language.....13
 - 5.4.2 Set time.....13
 - 5.4.3 Set date.....13
 - 5.4.4 Set day of the week.....13
 - 5.4.5 Starting method.....13
 - 5.4.6 Single phase start.....13
 - 5.4.7 Auto shutdown.....13
 - 5.4.8 Controller HP.....13
 - 5.4.9 Nominal voltage.....13
 - 5.4.10 Phases.....14
 - 5.4.11 System frequency.....14
 - 5.4.12 CT Ratio.....14
 - 5.4.13 Motor FLA.....14
 - 5.4.14 Common alarm settings.....14
 - 5.4.15 Notification area settings.....14

5.4.16	Foam controller	14
5.4.17	Menu password	14
5.4.18	Controller serial number.....	14
5.4.19	Pump serial number.....	14
5.4.20	Save configuration to USB.....	14
5.4.21	Load configuration to USB.....	14
5.4.22	Save settings as factory default.....	14
5.4.23	Restore factory default settings.....	14
5.4.24	Screen brightness	14
5.4.25	Welcome screen	14
5.4.26	Screen lock.....	14
5.4.27	Customer service contact.....	14
	5.4.27.1. Save configuration	14
	5.4.27.2 Load configuration.....	15
5.4.28	Update firmware	15
5.4.29	Update languages	15
5.5	Help tab.....	15
5.5.1	Product manual	15
5.5.2	Service contact information	15
5.5.3	Factory contact information	15
5.6	Pressure settings tab	15
5.6.1	Start pressure	15
5.6.2	Stop pressure.....	15
5.6.3	Low pressure alarm	15
5.6.4	High pressure alarm.....	15
5.6.5	Start above pressure.....	15
5.6.6	Pressure variance recording.....	15
5.6.7	Hourly pressure recording.....	15
5.6.8	Low suction shutdown.....	15
5.6.9	Low foam shutdown	16
5.6.10	Proof pressure switch	16
5.6.11	Pressure units	16
5.6.12	Pressure transducer.....	16
5.6.13	Calibrate transducer	16
5.7	Timer values tab	16
5.7.1	Minimum run time (RPT).....	16
5.7.2	Acceleration timer (AT).....	16
5.7.3	Sequential start time.....	16
5.7.4	Fail to start timer (FTS)	16
5.7.5	Fail to stop timer	16
5.7.6	Weekly motor test timer.....	17
5.8	Alarm setpoints tab.....	17
5.8.1	Phase reversal.....	17
5.8.2	Phase failure alarm setpoint.....	17
5.8.3	Motor overload setpoint.....	17

Index

- 5.8.4 Transducer fail pump start..... 17
- 5.8.5 Abort motor test on low voltage..... 17
- 5.8.6 Voltage alarm settings..... 17
- 5.8.7 Frequency alarm settings..... 17
- 5.9 Inputs/outputs tab 17
 - 5.9.1 Inputs 17
 - 5.9.2 Outputs 17
- 5.10 History stats diag. Tab (history statistics diagnostics)..... 18**
 - 5.10.1 Message history 18
 - 5.10.2 Controller statistics 18
 - 5.10.3 Controller diagnostics 19
 - 5.10.4 Startup information 19
 - 5.10.5 Save to USB..... 19
- 6.0 Automatic transfer switch (ATS) 20**
 - 6.1 General 20
 - 6.2 Main contacts..... 20
 - 6.3 ATS electrical control circuit 20
 - 6.4 Mechanical transfer mechanism..... 20
 - 6.5 ATS control board & touchscreen display..... 21
 - 6.5.1 Inputs 21
 - 6.5.2 Outputs 21
 - 6.5.3 Touchscreen display ATS graphics 21
 - 6.6 Programming..... 21
 - 6.6.1 Time delay S1 to S2..... 21
 - 6.6.2 Time delay S2 to S1..... 21
 - 6.6.3 Time delay neutral..... 21
 - 6.6.4 Time delay engine start 21
 - 6.6.5 Time delay S2 fail..... 21
 - 6.6.6 Time delay engine cooldown 21
 - 6.6.7 Dual utility 21
 - 6.6.8 Weekly engine test timer..... 22
- 7.0 Optional add-on boards 23**
 - 7.1 Relay output board..... 23
 - 7.1.1 Programming 23
 - 7.2 Secondary 4-20 mA device 23
 - 7.2.1 Programming:..... 23
 - 7.3 MODBUS Board 23
 - 7.3.1 Programming:..... 23
 - 7.3.2 MODBUS dip switch settings 23
 - 7.4 Supervisory alarm option board 23
 - 7.4.1 Programming:..... 23

Appendix A: menu structure24

Appendix B: startup tab menu structure.....25

Appendix C (a): panel setup tab menu structure.....26

Appendix C (b): panel setup tab menu structure continued.....27

Appendix C (c): panel setup tab menu structure continued.....28

Appendix C (d): panel setup tab menu structure continued29

Appendix C (e): panel setup tab menu structure continued.....30

Appendix D: help tab menu structure.....31

Appendix E (a): pressure settings tab menu structure,.....32

Appendix E (b): pressure settings tab menu structure continued,33

Appendix E (c): pressure settings tab menu structure continued.....34

Appendix F: timer values tab menu structure35

Appendix G (a): ATS settings tab menu structure.....36

Appendix G (b): ATS settings tab menu structure continued.....37

Appendix H (a): alarm setpoints tab menu structure38

Appendix H (b): alarm setpoints tab menu structure continued.....39

Appendix I (a): inputs / outputs tab menu structure40

Appendix I (b): inputs / outputs tab menu structure continued41

Appendix J: History stats diag. Tab menu structure.....42

Appendix K: Relay option board– tab menu structure.....43

Appendix L (a): 4-20 mA device – tab menu structure.....44

Appendix L (b): 4-20 mA device – tab menu structure continued45

Appendix M: MODBUS board – tab menu structure.....46

Appendix N: Supervisory alarm option board – tab menu structure.....47

Appendix O: Alarm/Status messages48

Appendix P: I/O board error codes.....50

Appendix Q: Power wire cable reference51

1.0 Introduction

1.1 Safety

This technical document is intended to cover most aspects associated with the installation, application, operation, and maintenance of the EPCT Fire Pump Controller. It is provided as a guide for authorized and qualified personnel only in the selection and application of the EPCT Controller. If further information is required by the purchaser regarding particular installation, application, or maintenance activity, please contact an authorized EATON sales agent or the installing contractor.

1.2 Warranty

No warranties, expressed or implied, including warranties of fitness for a particular purpose of merchantability, or warranties arising from course of dealing or usage of trade, are made regarding the information, recommendations and descriptions contained herein. In no event will EATON be responsible to the purchaser or user in contract, in tort (including negligence), strict liability or otherwise for any special, indirect, incidental or consequential damage or loss whatsoever, including but not limited to damage or loss of use of equipment, plant or power system, cost of capital, loss of power, additional expenses in the use of existing power facilities, or claims against the purchaser or user by its customers resulting from the use of the information and descriptions contained herein.

1.3 Safety precautions

All safety codes, safety standards, and/or regulations must be strictly observed in the installation, operation, and maintenance of this device.

CAUTION

Completely read and understand the material presented in this document before attempting installation, operation, or application of the equipment. In addition, only qualified persons should be permitted to perform any work associated with this equipment. Any wiring instructions presented in this document must be followed precisely. Failure to do so could cause permanent equipment damage.

1.4 Product overview

The EPCT Controller is a comprehensive, multi-function microprocessor-based Fire Pump Controller.

Designed to meet the needs of markets worldwide, the EPCT controller meets the requirement of and is certified by the following authorities: Underwrites Laboratories (UL), Underwriters Laboratories of Canada (ULC), Complies with UL 218 & UL 1008 (if equipped with an Automatic Transfer Switch (ATS)), Factory Mutual 1321/1323 (FM), ANSI/NFPA 20, Article 695 of ANSI/NFPA 70, National Electrical Code (NEC), Canadian Standards Association (CSA), CSA-C22.2 standard for Fire Pump Controllers and Automatic Transfer Switches, and meets the requirements for U.S.B. / C.B.C Seismic approvals. Starting types of the EPCT Fire Pump Controller include the following: FD/FT30-Across the Line, FD/FT40-Part Winding, FD/FT50-Primary Resistor, FD/FT60-Autotransformer, FD/FT70-Wye-Delta (Star-Delta) Open Transition, FD/FT80-Wye-Delta (Star-Delta) Closed Transition, FD/FT90-Soft Start, and FDM30-Medium Voltage Across the Line. All products, except the FDM30, can be offered as an Additive (Foam) system and/or with an Automatic Power Transfer Switch.

The rated impulse withstand voltage rating of this assembly is 10kV.

2.0 Installation and electrical connections

2.1 Mounting

Carefully unpack the controller and inspect thoroughly.

The controller should be located as close as is practical to the motor it controls and shall be within sight of the electric motor, preferably ten feet or less.

The EPCT controller is designed for either wall or floor mounting; use Grade 5 bolts. Note that the controller is not free standing and must be mounted with feet or bolted securely to a wall. For dimensional and weight data please refer to the respective data sheets for the various types of Fire Pump Controllers.

2.2 Pressure switch connections

NOTICE

Water lines to the pressure switch must be free from dirt and contamination

The EPCT is equipped with a pressure sensor. The controller is provided with a 1/2" NPT female system pressure connection located on the bottom, external side of the enclosure. The connection should be installed as per NFPA, pamphlet no. 20.

The actual pressure is displayed on the main display. Precise start and stop pressure set points can be programmed in the controller. Refer to Section 5 for programming instructions.

The maximum operating pressure of the pressure sensor and internal plumbing components is listed on the controller nameplate.

2.3 Electrical connections

NOTICE

All conduit connections to the controller are recommended to be installed on the bottom of the controller. Refer to the associated dimensional drawing for reference. Drilling or installing conduit above the microprocessor boards may void warranty.

All electrical connections should meet national and local electrical codes and standards.

The controller should be located or so protected that it will not be damaged by water escaping from pumps or pump connections. Current carrying parts of controllers shall be a minimum of 12 inches (305mm) above the floor.

Prior to starting, verify all data on the nameplate such as: catalog number, AC line voltage, horsepower, and frequency.

Inspect all electrical connections, components, and wiring for any visible damage. Correct as necessary. Ensure that all electrical connections are tightened before energizing.

Refer to the wiring schematic affixed to the enclosure door for all wiring information pertaining to the incoming AC power supply and motor wiring.

Install necessary conduit using proper methods and tools. Recommend entry point is on the bottom of the enclosure.

Incoming AC line voltage is clearly marked L1, L2, L3, and ground, located at the top of the enclosure.

2.3.1 Wire sizes

For control wiring, use #14 AWG wire for all electrical connections.

For power wiring sizes refer to Appendix Q.

2.3.2 Electrical checkout instructions

The EPCT controller is designed to be phase sensitive. L1, L2 & L3 should be connected to A, B & C respectively. Energize the controller by closing the isolation switch (MIS) and circuit breaker (CB). If the phases are connected incorrectly, the 'Phase Reversal' alarm and graphic will be displayed on the screen. To correct this condition, refer to Appendix H to correct the phase reversal setting.

The EPCT has a phase reversal setup procedure that guides the user through a step by step process to program the phase rotation. With the controller energized, operate the 'Bump Motor' feature through the Setup Phase Reversal in the Startup tab on the display to check the rotation of the motor. If the rotation is incorrect, disconnect power and reverse the connection of the load terminals of the motor contactor T1, T2 & T3. If the controller is equipped with an automatic transfer switch (ATS), the guide will prompt the user to start the generator, transfer and bump the motor.

Note: On models Primary Resistor (FD/FT40), Wye Delta (Star-Delta) Open (FD/FT70) and Wye Delta (Star-Delta) Closed (FD/FT80) models, the connection must be changed on both contactors, 1M and 2M.

Adjust the pressure set points detailed in Appendix E.

With the controller isolated and the 'Start Pressure' and 'Stop Pressure' values programmed, energize the controller. If the system water pressure is lower than the start pressure, the controller will start the pump. If the controller is set up for fully automatic operation, the controller will stop the pump when the pressure is above the stop point and the running period timer (RPT) has completed its timed interval. The system pressure must be equal to or greater than the programmed stop pressure value, otherwise the pump will stop only when the pushbutton is pushed. If the controller is not setup for automatic shutdown operation (programmed for manual stop mode), the stop pushbutton must be operated to stop the pump.

The circuit breaker setting is factory set and should not be adjusted.

If required, the running period timer (RPT) must be set for a minimum of ten (10) minutes. Refer to Appendix F for programming of the RPT.

Installation and electrical connections

If the sequential start timer (SST) is required refer to Appendix F. If not required set the SST to disabled. If required, the lead pump SST should be set to disabled and the lag SST to five (5) to ten (10) seconds. If there are more than two pumps in the system, allow a ten (10) second delay between pumps.

The acceleration timer (AT) is used for reduced in-rush current controllers only. The AT will be factory set but will automatically adjust depending on the starting method that the controller is programmed to. If it is found that more time is required to allow the pump to come up to speed, the timer may be adjusted up to 10 seconds. Refer to Appendix F for programming of the AT.

If the Undervoltage/Overvoltage alarms are present, check the programmed values by referring to Appendix H. If the values are programmed to their maximum and the alarms continue to occur, check the main voltage supply to ensure that the power available is dependable as per NFPA, Pamphlet 20 standards.

3.0 Hardware description

3.1 General

The purpose of this section is to familiarize the reader with the EPCT controller hardware, its nomenclature, and to list the unit's specifications.

3.2 Display board

The display board is accessible from the outside of the door. The front panel provides a means to:

- Alert the user to specific conditions
- Program the controller
- Set and monitor the operating parameters

3.2.1 Memory

The EPCT has non-volatile memory which allows the recording and storage of up to 65,000 events.

3.2.2 Battery backup

A ten (10) year, replaceable lithium battery allows a time clock to be kept during power failures. Removal of the battery does not affect programming.

3.2.3 Color touchscreen specifications

Aspect Ratio: 5:3

Resolution: 800x480 WQVGA

Type: LCD display

Viewing Area: 7 inches diagonal

Rating: NEMA 4/4X

3.2.4 USB port

The USB port located on the door is meant for downloading the controller message history, statistics, diagnostics, startup, and configuration files. The controller firmware can be uploaded and the controller configuration can be both uploaded and downloaded. Compatible USB flash drive formats include FAT16 & FAT32.

3.3 Power I/O board

The Power I/O board is used for all connections pertaining to the operation of the controller. From the remote inputs, starting conditions, and the alarm relay outputs.

Refer to the schematic diagram mounted on the inside of the controller door for all connection points specific to the controller.

3.4 ATS board (if equipped)

The ATS board is used for all connection points pertaining only to the automatic transfer switch. These connection points control the starting of the backup engine/generator, and output relay for Source 2 Disconnected.

Refer to the schematic diagram mounted on the inside of the controller door for all connection points specific to the controller.

3.5 Main isolating switch/circuit interrupter

The main isolating switch (MIS) is intended for isolating an electric circuit from its source of power. It has no interrupting rating and must be externally operable.

The circuit interrupter (CB) is used to disconnect a running pump motor, if necessary. The CB also provides short circuit protection for the controller and the pump motor and operates in conjunction with the Locked Rotor Protector (LRP). In case of a short circuit the CB will trip instantaneously. In the case of seizure of the pump or motor while starting or running the LRP will trip the CB, via a shunt trip, within twenty (20) seconds, as per NFPA 20 standards.

When necessary, a current limiter attachment may be mounted on the bottom of the CB to increase the interrupting capacity.

If one or more of the current limiter fuses blows, the cause must be repaired immediately and new current limiters installed when repairs are complete.

The isolating switch and circuit interrupter are interlocked such that the enclosure door cannot be opened with the handle in the On position, except by qualified electrical personnel. This is accomplished by the use of a defeater screw located on the side of the operator handle.

Note: The isolation switch is not required on Limited Service controllers. A circuit breaker with a magnetic-only trip setting will be used.

3.6 Contactor(s)

The contactor(s) (M, in full voltage and soft start controllers; 1M and 2M, in part winding; M and A, in primary resistor; R, S and Y, in autotransformer; 1M, 2M, 1S and 2S, in wye-delta) connect the pump motor to the supply, under control of the pressure sensor, start pushbutton, remote starting inputs, or emergency handle.

The contactor coil(s) are connected to the supply voltage of the controller. If a replacement coil is ever required, the correct voltage must be ordered.

Hardware description

3.7 External pushbuttons

- **Start** - The start pushbutton is used to initiate a local manual start of the pump motor.
- **Stop** - The stop pushbutton will initiate the stopping sequence of the fire pump motor. Releasing the stop button will put the controller back into the automatic mode. If a starting condition exists, the pump motor will start again once the stop button is released.

3.8 Transfer switch components

Refer to Section 6 for the description of the transfer switch components.

4.0 Operation

4.1 General

This section specifically describes the operation and functional use of the EPCT controller. The practical use of and operation within each category will be discussed. In this section, it is assumed that prior sections of this manual were reviewed, and that the operator has a basic understanding of the hardware

4.2 Welcome screen

When the EPCT controller is first energized, the Welcome Screen will be displayed (refer to 4.2.1.1).

While on the Welcome Screen, the controller will not start the pump regardless of any present starting conditions; this screen will show all present starting conditions. The screen comes equipped with a five (5) minute countdown timer where, when it expires, the controller will exit the Welcome Screen to the Home tab and resume normal operation.

4.2.1 Welcome screen and home screen graphics

4.2.1.1. Welcome screen

The three (3) buttons on this screen are CLOSE AND DISABLE WELCOME SCREEN, CLOSE WELCOME SCREEN AND RUN ON NEXT STARTUP, and QUICK SETUP. The operation is as follows:

- Close and Disable Welcome Screen will bring the controller to the Home tab and, upon re-energizing the controller, the controller will not show the Welcome Screen.
- Close Welcome Screen and Run on Next Startup will bring the user to the Home tab but, upon re-energizing the controller, the controller will show the Welcome Screen.
- Quick Setup bring the user to directly to the Quick Setup menu where the Time, Date, Start Pressure, Stop Pressure, Enable or Disable Automatic Shutdown, and Minimum Run Timer can be programmed. By accepting or disregarding the programming from this menu, the user will be brought back to the Welcome Screen.

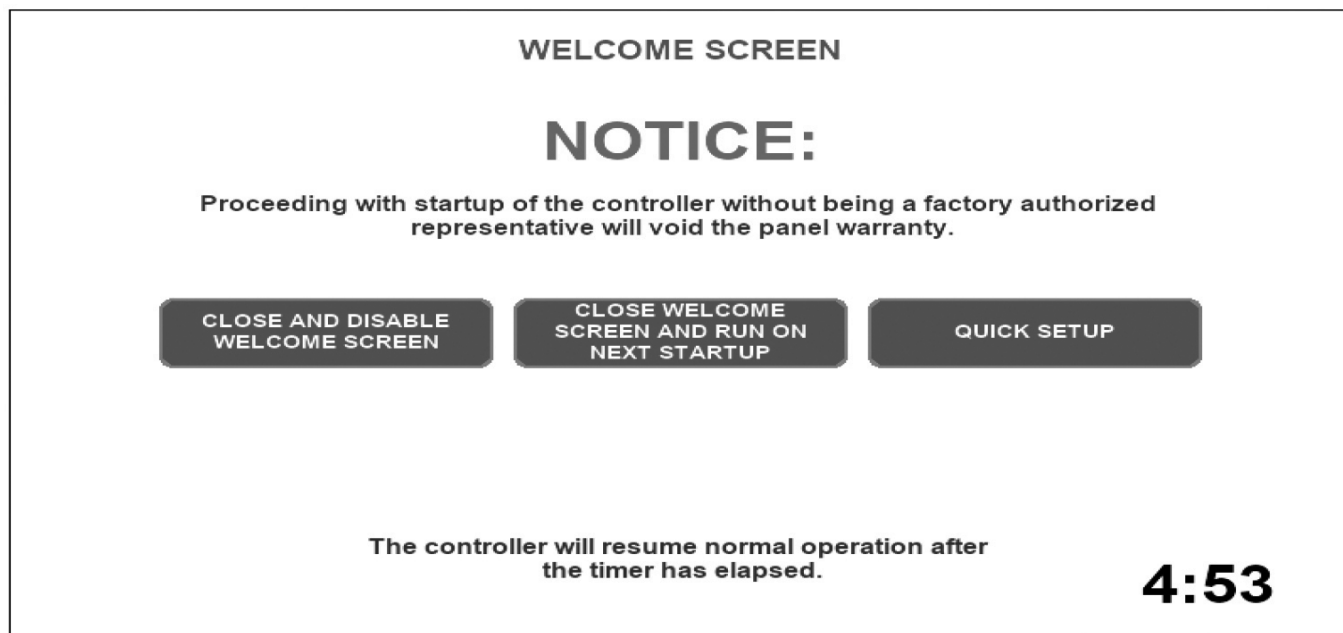

Operation

4.2.1.2 Home Tab without an ATS

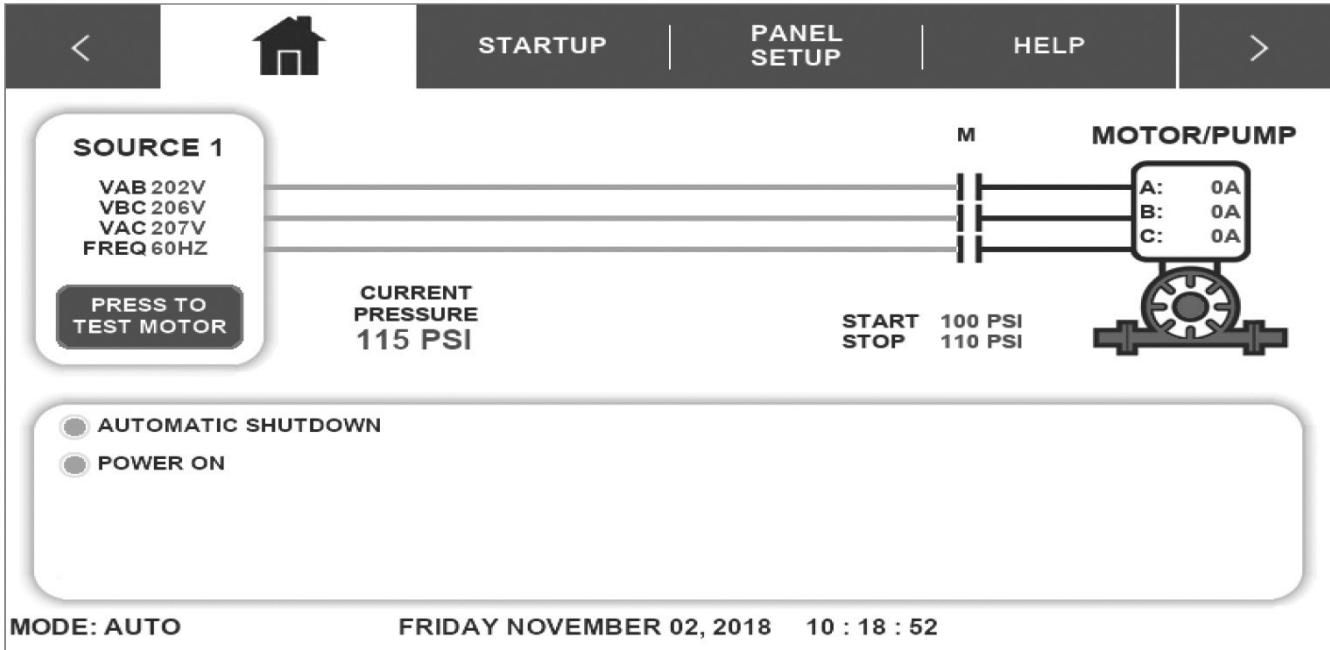

Fig 1. HOME tab (idle)

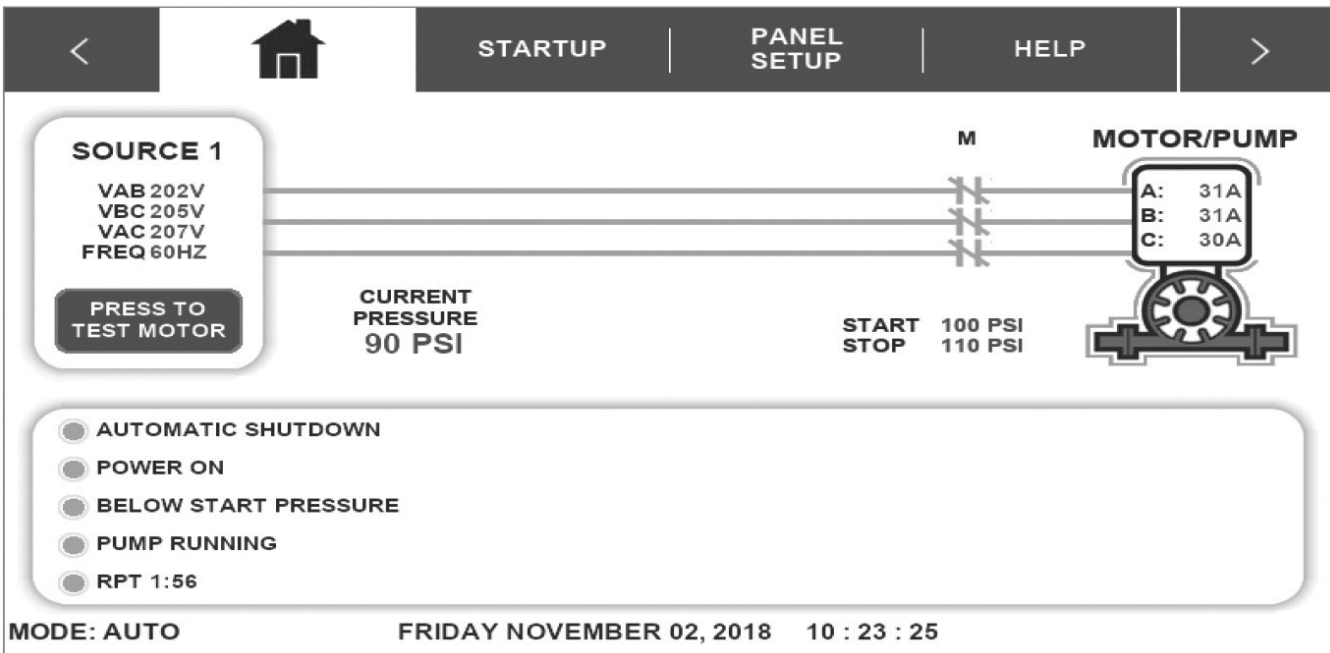

Fig 2. HOME tab (pump running)

The HOME tab will display the incoming utility voltage and frequency along with the state of the contactor(s) and motor. The HOME tab will display the current system pressure reading along with the programmed Start and Stop setpoints. At the bottom of the HOME tab is the Notification Area which shows all status, alarms, and timers indications with visuals to show which signals are sounding the audible alarm; the date, time, and operation mode are display below the Notification Area.

When the controller receives a call-to-start signal and successfully starts the pump motor, visual indication will be provided by showing the “M” contact in a closed state, a border around the Motor/Pump, and a motor spinning graphic. There will be a Pump Running status in the Notification Area

4.2.1.3. Home screen of a controller without an ATS (motor running)

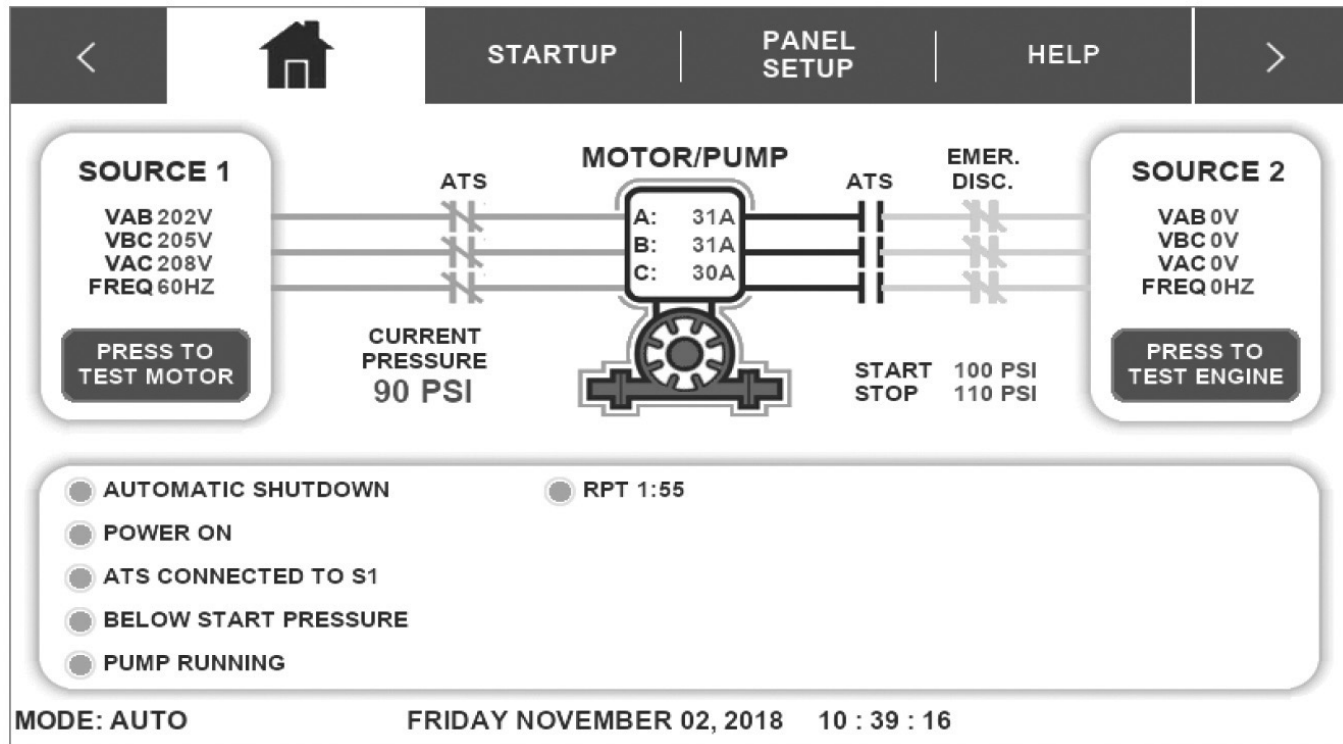

Fig 3. HOME tab with ATS

The HOME tab will display the incoming voltage and frequency for both sources along with the state of the transfer switch breakers, Source 2 external disconnect handle, and the motor. The HOME tab will display the current system pressure reading along with the programmed Start and Stop setpoints. At the bottom of the HOME tab is the Notification Area which shows all status, alarms, and timers indications with visuals to show which signals are sounding the audible alarm; the date, time, and operation mode are display below the Notification Area.

When the controller receives a call-to-start signal and start the pump motor, visual indication will be provided by showing a border around the Motor/Pump, and a motor spinning graphic. There will be a Pump Running status in the Notification Area.

4.3 Automatic start / stop

The EPCT controller will automatically start and stop the fire pump motor as dictated by the features supplied and their programmed set-point values. A summary of the controller intelligence and supervisory circuits that constantly monitor the condition of the system pressure, inputs, and system alarm points is provided.

4.3.1 Manual start sequence

Manual start is defined as a local start, remote manual start, remote manual start/stop, or emergency start. Whenever the motor is running via a manual start, the motor needs to be manually stopped via the stop pushbutton located on the enclosure flange.

Operation

4.3.2 Automatic start sequence

Automatic start is defined as a low-pressure condition, deluge valve start or a remote auto start. Whenever the motor is running via an automatic start, the motor can automatically stop once all starting conditions have returned to normal and the RPT has finished its timing cycle. If the controller is programmed for manual stop, the motor needs to be manually stopped via the local stop pushbutton located on the enclosure flange.

4.4 Control inputs

The EPCT has ten (10) programmable inputs.

CAUTION

Severe damage could be caused to the microprocessor boards if a voltage is applied to these inputs. They are internally powered.

4.4.1 Control input descriptions

The Control Input state definitions are as follows.

Connected - When the input is shorted by an external contact or connection.

Disconnected - When the input is NOT shorted by an external contact or connection.

The Control Input operations are defined as follows.

Note: Terminal 49 is common to all the inputs outlined below.

4.4.1.1. Remote manual start

When this input is in the “Connected” state, the controller will initiate the manual start sequence. Remote start will ignore the sequential start timer (SST) and the minimum run timer (RPT) and will require a manual stop signal to shut down the pump.

4.4.1.2. Remote manual stop

When this input is in the “Connected” state, the controller will not permit starting of the pump with the exception of Emergency Start and will shut down the pump, if already running. Remotely stopping a full service fire pump controller needs to be approved by the local authority.

4.4.1.3. Remote manual start/stop

When this input is in the “Connected” state, the controller will initiate the manual start sequence. Remote start will ignore the sequential start timer (SST) and the minimum run timer (RPT) and will require a manual stop signal to shut down the pump. When this input is in the “Disconnected” state, the controller will shut down the pump, if already running. Remotely stopping a full service fire pump controller needs to be approved by the local authority.

4.4.1.4. Remote auto start

When this input is in the “Connected” state, the EPCT controller will initiate an automatic start sequence. If programmed to automatically shutoff the pump, when the input is in a “Disconnected” state and the RPT has elapsed, the controller will shut down the pump. This input is typically wired to a separate pressure switch when the use of a pressure transducer is not desired.

Note: When the controller is programmed for foam operation, the remote auto start input be a normally closed input that will open to initiate a start.

4.4.1.5. Deluge valve start

When this input is in the “Disconnected” state, the EPCT controller will initiate an automatic start sequence. If programmed to automatically shutoff the pump, when the input is in a “Connected” state and the RPT has elapsed, the controller will shut down the pump. This input is typically wired to remote water control equipment that starts the controller before the pressure transducer does.

4.4.1.6. Low suction

When this input is in the “Connected” state, the EPCT controller will signal a visual indication in the notification area for Low Suction. If the controller is programmed for Low Suction Shutdown it will initiate the shutdown sequence. Refer to Section 5 to program Low Suction Shutdown.

4.4.1.7. Low foam level

When this input is in the “Connected” state, the EPCT controller will signal a visual indication in the notification area for Low Foam Level. If the controller is programmed for Low Foam Shutdown it will initiate the shutdown sequence. Refer to Section 5 to program Low Suction Shutdown.

4.4.1.8. Proof pressure switch

When this input is in the “Connected” state, the EPCT controller will signal a visual indication in the notification area for Proof Pressure Switch. If Proof Pressure Switch is enabled, the controller requires that this input is “Connected” before allowing a start sequence. Refer to Section 5 to program Proof Pressure Switch.

4.4.1.9. Low room temperature

When this input is in the “Connected” state, the EPCT controller will signal a visual indication on the main display board for Low Room Temperature. The Common Alarm relay will also de-energize for remote monitoring of this alarm.

4.4.1.10. High room temperature

When this input is in the “Connected” state, the EPCT controller will signal a visual indication on the main display board for High Room Temperature. The Common Alarm relay will also de-energize for remote monitoring of this alarm.

4.4.1.11. Interlock

When this input is in the “Connected” state, the EPCT controller will not permit a start of the motor except for Emergency Start. This input is typically used in backup style systems. For example, the Engine Running contacts from the backup Diesel Engine Controller are wired into this input. When the Diesel Engine is running, it will lock out the EPCT panel to prevent it from starting.

4.4.1.12. Low reservoir

When this input is in the “Connected” state, the EPCT controller will signal a visual indication on the main display board for Low Reservoir. The Common Alarm relay will also de-energize for remote monitoring of this alarm.

4.4.1.13. High reservoir

When this input is in the “Connected” state, the EPCT controller will signal a visual indication on the main display board for High Reservoir. The Common Alarm relay will also de-energize for remote monitoring of this alarm.

4.4.1.14. Go to source 1

When this input is in the “Connected” state, the EPCT controller will transfer the transfer switch to Source 1, if it is not already on Source 1, regardless of the state of the incoming voltage. “Disconnecting” this input, the controller will resume normal transfer switch operations.

4.4.1.15. Go To Source 2

When this input is in the “Connected” state, the EPCT controller will transfer the transfer switch to Source 2, if it is not already on Source 2, regardless of the state of the incoming voltage. “Disconnecting” this input, the controller will resume normal transfer switch operations.

4.4.1.16. Enable Sequential Start

When this input is in the “Connected” state and the timer is programmed, the controller will delay all automatic starting means for the duration of the programmed timer.

4.5 Output relays

The primary control outputs of the EPCT controller are dry relay contacts. These relays are comprised of two separate “Form C” outputs for Power/Phase Failure, Phase Reversal, Common Alarm, and Pump Run. The alarm relays are UL/CSA rated at 8A 250Vac / 30Vdc.

Each relay has a green LED on the I/O board to indicate the relay status. If the LED is “On” the relay is energized and “Off” the relay is de-energized.

4.5.1 Startup (1CR)

The Startup (1CR) relay is the motor start relay. It will energize when there is a call-to-start. When the relay closes, it provides full voltage to the start/run contactor. This is not a reprogrammable relay.

4.5.2 Acceleration (2CR)

The Acceleration (2CR) relay is used on reduced voltage starting controllers only. It will energize after the programmed acceleration time delay expires. When the relay closes, it provides full voltage to the run contactor(s). This is not a reprogrammable relay.

4.5.3 Common alarm (3CR)

The Common Alarm (3CR) relay is a normally energized relay and is used to alarm on various alarming conditions. The relay will de-energize (change state) when any of the events programmed into the Common Alarm Settings in the Panel Setup tab becomes true.

4.5.4 Power / phase failure (4CR)

The Power/Phase Failure (4CR) relay is a normally energized relay and is used to alarm when there is a voltage or phase imbalance. The relay will de-energize when the voltage or phasing levels exceed the allowable, programmed threshold.

4.5.5 Phase reversal (5CR)

The Phase Reversal (5CR) relay is used for remote monitoring of a phase reversal condition. The phase reversal alarm is factory set in an ABC configuration.

4.5.6 Pump run (6CR)

The Pump Run (6CR) relay is used for remote monitoring when the pump is running. When the line current exceeds 20% of the programmed motor FLA, this relay will energize.

5.0 Programming

5.1 Introduction

The EPCT controller is fully programmable from the device's faceplate. Users can program set points as well as other parameters. The time, date, and set points can only be changed from the menu system.

The menu system is broken down to tab systems. These include, Home, Startup, Panel Setup, Help, Pressure Settings, Timer Values, ATS Settings (if equipped), Alarm Setpoints, Inputs/Outputs, History/Statistics/Diagnostics, and Optional Output Card(s) (if equipped).

5.2 Navigation

In order to navigate through the EPCT operating system, press the tabs at the top of the screen to go through the menu. If the main menu password is enabled, the user will be prompted to enter the password to access any of the tabs except for Help and History/Statistics/Diagnostics.

NOTICE

It is recommended to set up a main menu password to help prevent any unauthorized access to the controller. This will help prevent reprogramming the controller that will impede the operation of the fire pump controller.

The controller does come with the ability to "Lockout" the display after thirty (30) minutes of inactivity to minimize accidental inputs. This feature will not inhibit the normal operation of the controller. To unlock the display, the user will be prompted to enter in "EPCT".

In order to increase the longevity of the display board, the controller will activate the screensaver after thirty (30) minutes of inactivity. The screen saver will turn the screen black and will show a moving EATON logo. To deactivate the screensaver simply press anywhere on the screen.

All EPCT controller programmable features and associated set-point possibilities are presented in Table 1.

Table 1

Description	Range
Panel setup	
Language	English / French / Spanish / Portuguese / Turkish / Italian / Polish / Simplified Chinese / Dutch
Set time	24 Hours
Set date	Any valid date
Set day of the week	Any valid day of the week
Starting method	Across the Line / Part Winding / Primary Resistor / Autotransformer/ WYE-Delta Open / Wye-Delta Close / Soft Start
Single phase start	Enabled / Disabled
Auto shutdown	Enabled / Disabled
Motor HP	0-9999 HP
Nominal voltage	200-7200V
Phases	Single Phase / Three Phase

Description	Range
System Frequency	50Hz / 60Hz
CT Ratio	50:0.1 / 100:0.1 / 150:0.1 / 300:0.1 / 500:0.1 / 800:0.1 / 1200:0.1
Motor FLA	1-999 A
Foam Controller	Enabled / Disabled
Menu Password	One (1) to seven (7) digit numeric / Disabled
Controller Serial Number	Standard keyboard entry with space for fifty (50) digits - Numeric and/or Alphabetical -
Pump Serial Number	Standard keyboard entry with space for fifty (50) digits - Numeric and/or Alphabetical
Screen Brightness	20%, 40%, 60%, 80%, 100%
Enable Welcome Screen	Enabled / Disabled
Screen Lock	Enable/Disable
Customer service contact	
Enable Password Protection	One (1) to seven (7) digit numeric / Disabled
Company Name	Standard keyboard entry with space for fifty (50) digits - Numeric and/or Alphabetical
Contact Name	Standard keyboard entry with space for fifty (50) digits - Numeric and/or Alphabetical
Phone Number	Numeric entry with space for 15 digits
Email	Standard keyboard entry with space for fifty (50) digits - Numeric and/or Alphabetical
Service message trigger	
Number of Hours Run	1-999 Hour
Number of Starts	1-999 Pump Runs
Specific Time and Date	24 Hours - Any valid date
De-energize Common Alarm	Enabled / Disabled
Pressure settings	
Start Pressure	0-999 PSI / Disabled
Stop Pressure	0-999 PSI / Disabled
Low Pressure Alarm	0-999 PSI / Disabled
High Pressure Alarm	0-999 PSI / Disabled
Start Above Pressure	0-999 PSI / Disabled
Pressure Variance Recording	1-999 PSI / Disabled
Hourly Pressure Recording	Enabled / Disabled
Low suction shutdown	
Shutdown Delay	0-99 Seconds / Disabled
Reset Mode	Automatic / Manual
Automatic Reset Delay	0-99 Seconds / Disabled
Low foam shutdown	
Shutdown Delay	0-99 Seconds / Disabled
Reset Mode	Automatic / Manual
Automatic Reset Delay	0-99 Seconds / Disabled
Proof Pressure Switch	Enabled / Disabled
Pressure Units	PSI / BAR / kPa
Pressure Transducer	Enabled / Disabled
Calibrate Pressure Transducer	Calibrate Using 0 PSI / Calibrate Using Current Pressure / Reset to Factory Default
Timer values	
Minimum Run Time	Four (4) digit numeric entry in Minutes: Seconds / Disabled
Acceleration Timer	0-10 seconds / Disabled
Sequential Start Timer	0-999 seconds / Disabled
Fail to Start Timer	0-999 seconds / Disabled

Description	Range
Fail to Stop Timer	0-999 seconds / Disabled
Weekly motor test timer	Enabled / Disabled
Day of the Week	Any valid day of the week
Time of Day	24 Hours
Test Interval	1-52 weeks
Run Time	Four (4) digit numeric entry in Minutes: Seconds / Disabled
Drain Valve Solenoid	Enabled / Disabled
ATS settings (if equipped)	
Time Delay S1 to S2	Three (3) digit numeric entry in Minutes: Seconds / Disabled
Time Delay S2 to S1	Three (3) digit numeric entry in Minutes: Seconds / Disabled
Time Delay Neutral	Three (3) digit numeric entry in Minutes: Seconds / Disabled
Time Delay Engine Start	Three (3) digit numeric entry in Minutes: Seconds / Disabled
Time Delay S2 Fail	0-9 seconds / Disabled
Time Delay Engine Cooldown	Three (3) digit numeric entry in Minutes: Seconds / Disabled
Dual utility	Enabled / Disabled
Preferred Source	Source 1 / Source 2
Weekly engine test timer	Enabled / Disabled
Day of the Week	Monday / Tuesday / Wednesday / Thursday / Friday / Saturday / Sunday
Time of Day	24 Hours
Test Interval	1-52 weeks
Run Time	Four (4) digit numeric entry in Minutes: Seconds / Disabled
Transfer Load	Enabled / Disabled
Alarm setpoints	
Phase Rotation	ABC / CBA / Disabled
Phase Failure Alarm Setpoint	0-100% / Disabled
Motor Overlead Setpoint	100-999%
Transducer Fail Pump Start	Enabled / Disabled
Abort Motor Test on Low Voltage	Enabled / Disabled
Voltage alarm settings	
Source 1 Under Voltage	0-100% / Disabled (Dropout) 0-100% / Disabled (Pickup)
Source 1 Over Voltage	100-999% / Disabled (Dropout) 100-999% / Disabled (Pickup)
Source 2 Under Voltage	0-100% / Disabled (Dropout) 0-100% / Disabled (Pickup)
Source 2 Over Voltage	100-999% / Disabled (Dropout) 100-999% / Disabled (Pickup)
Frequency alarm settings	
Source 1 Under Frequency	0-100% / Disabled (Dropout) 0-100% / Disabled (Pickup)
Source 1 Over Frequency	100-999% / Disabled (Dropout) 100-999% / Disabled (Pickup)
Source 2 Under Frequency	0-100% / Disabled (Dropout) 0-100% / Disabled (Pickup)

Description	Range
Source 2 Over Frequency	100-999% / Disabled (Dropout) 100-999% / Disabled (Pickup)
Inputs/outputs	
Input 1	See Table 2
Input 2	See Table 2
Input 3	See Table 2
Input 4	See Table 2
Input 5	See Table 2
Input 6	See Table 2
Input 7	See Table 2
Input 8	See Table 2
Input 9	See Table 2
Input 10	See Table 2
Input On Delay Timer	0-999 seconds / Disabled
Input Off Delay Timer	0-999 seconds / Disabled
Latch Until Reset	Enabled / Disabled
Failsafe	Enabled / Disabled
3CR Relay	See Table 3
4CR Relay	See Table 3
5CR Relay	See Table 3
6CR Relay	See Table 3
Pressure Above	0-999 PSI / Disabled
Pressure Below	0-999 PSI / Disabled
Load Shed Controller Start Delay	0-10 seconds / Disabled
Relay On Delay Timer	0-999 seconds / Disabled
Relay Off Delay Timer	0-999 seconds / Disabled
Latch Until Reset	Enabled / Disabled
Failsafe	Enabled / Disabled

5.3 Startup tab

Refer to Appendix B for the menu structure of the Startup tab.

5.3.1 Quick setup

Quick Setup is a step-by-step process that allows the user to program the time, day of the week, date, start pressure, stop pressure, automatic shutdown, and minimum run time (if automatic shutdown was enabled). If all settings are correct, the user will press Accept to save the changes.

5.3.2 Setup phase reversal

Guides the user through a step-by-step process to verify that the motor is or is not spinning in the correct direction. Pressing “Motor Bump” will start a five (5) second countdown timer and, once elapsed, will bump the motor for a period of one (1) second. If spinning correctly, the controller will save the phase reversal setpoint into the programming. If the motor is not spinning correctly, the controller will provide a prompt on the necessary changes required.

For controllers equipped with an ATS, the sequence will continue. Pressing the “Start Generator/Transfer” will initiate a call-to-start on the generator and, once voltage is available on the Source 2 input, the ATS will transfer to

Programming

Source 2. Pressing “Motor Bump” will start a five (5) second countdown timer and, once elapsed, will bump the motor for a period of one (1) second. If spinning correctly, the controller will save the phase reversal setpoint into the programming. If the motor is not spinning correctly, the controller will provide a prompt on the necessary changes required.

5.3.3 Flow test

Records the voltage, current, pressure, and flow (if equipped) for a given flow rate. This information is stored in the Startup file that can be downloaded onto a USB drive or viewed through the History/Statistics/Diagnostics tab.

5.3.4 Manual/Automatic start

Records the number of times and the duration of each run, both via Automatic and Manual means into the Startup file.

Manual Starts provides a Start and Stop button on screen to initiate manual calls to start. The screen will show the voltage, frequency, current, and pressure along with the number of starts.

Automatic Starts provides a “Drop Pressure” button that will energize the drain valve solenoid to drop pressure within the sensing line. When the controller registers a low pressure condition, the drain valve will close, and the controller will initiate an automatic call-to-start. If activating the drain valve solenoid is not ideal, the user can manually drop pressure from the sensing line to achieve the same outcome.

If equipped with an ATS, means are provided on both Manual and Automatic Start screens to start the generator and transfer over to the secondary source without having to drop out normal power.

5.3.5 Test alarm

Buttons are used to trigger specific output relays to verify alarm connections and general operation of the relay. The relay will stay latched until either the button is depressed again or until the user leaves the screen.

5.3.6 USB download

Allows the user to save the statistics, diagnostics, message history, startup, and configuration files to a USB device.

5.4 Panel setup tab

Refer to Appendix C for the menu structure of the Panel Setup tab.

5.4.1 Language

Nine (9) languages are offered as standard: English, French, Italian, Spanish, Portuguese, Chinese, Polish, Dutch, and Turkish. Refer to Appendix B for programming.

5.4.2 Set time

Factory set to Mountain Standard Time (MST). This menu item allows the user to adjust the time in a 24-hour format.

5.4.3 Set date

Factory set but allows the user to adjust if needed.

5.4.4 Set day of the week

Factory set but allows the user to adjust if needed.

5.4.5 Starting method

Used to differentiate what starting method the controller what built to. Changing the starting method also adjusts the acceleration timer. The acceleration timer can be further adjusted in the Timer Values tab. These are the default acceleration timer for each Starting Method:

- Across the Line** – Disabled
- Part winding** – 2 Seconds
- Primary resistor** – 2 Seconds
- Autotransformer** – 2 Seconds
- Wye delta open** – 2 Seconds
- Wye delta closed** – 2 Seconds
- Soft start** – 4 Seconds

5.4.6 Single phase start

Factory disabled. If disabled, the controller will not allow starting if a single-phase condition is present; this will not shut down the motor if it has registered a valid pump run condition prior to the single-phase condition. If enabled, the controller will attempt to start the motor if a single-phase condition is present.

5.4.7 Auto shutdown

The automatic shutdown mode is user selectable; factory disabled. If the automatic shutdown mode is disabled, the pump motor must be stopped via the local stop pushbutton, whether or not the motor started via an automatic start. If the automatic shutdown mode is enabled, the controller will stop the pump motor automatically after all starting causes have been returned to normal (stop pressure has been achieved) and the running period timer elapsed.

5.4.8 Controller HP

Factory set. Used to set motor HP.

5.4.9 Nominal voltage

Factory set. Used to set the nominal system voltage. This value will also be used to determine any under voltage or overvoltage conditions, as well as phase loss conditions.

5.4.10 Phases

Factory set. Used to select the number of phases that will be connected to the controller.

5.4.11 System frequency

Factory set. Used to set the supply voltage frequency.

5.4.12 CT Ratio

Factory set. Used to set current transformer ratio.

5.4.13 Motor FLA

Factory set. Used to set motor FLA. This value can be adjusted on site to the value shown on the motor nameplate.

5.4.14 Common alarm settings

The user can enable or disabled specific conditions that will trigger the Common Alarm relay. The user can also enable or disable the audible alarm for specific conditions through this same menu.

5.4.15 Notification area settings

The user can enable or disable specific events from showing in the notification area on the Home tab. The color of the LED's can be selected from the following: green, red, blue, yellow, orange, and purple. The user can select whether the LED for a specific event should flash while active in the notification area.

5.4.16 Foam controller

This should be enabled if the controller will be used on a foam system. Certain inputs will automatically change and the pressure transducer will be disabled once this item is enabled.

5.4.17 Menu password

If enabled, the controller will prompt the user to enter the password when attempting to navigate through the controller menus.

5.4.18 Controller serial number

Factory set. Used to set controller serial number. The controller serial number will be located on the nameplate which is located on the main door.

5.4.19 Pump serial number

Used to set pump serial number. The pump serial number will be located on the nameplate which is typically located on the pump housing.

5.4.20 Save configuration to USB

The controller's configuration can be saved onto a USB drive. The configuration can then be used on other

controllers that require the same configuration setup. The configuration will not adjust functionality settings.

5.4.21 Load configuration to USB

A configuration file will be uploaded to the controller from a USB drive. The data located in the configuration file will change specific programmed setpoints in the controller.

5.4.22 Save settings as factory default

The current controller settings can be saved as the factory default for the controller. To change the factory default settings, the user will have to contact the factory. This should only be completed by authorized service representatives.

5.4.23 Restore factory default settings

Controller will be returned to the programmed Factory Default configuration.

5.4.24 Screen brightness

The screen brightness can be adjusted in 20% intervals.

5.4.25 Welcome screen

When enabled, the welcome screen will appear when the controller energizes.

5.4.26 Screen lock

When enabled and after thirty (30) minutes of inactivity, the screen will lock to minimize accidental inputs. This feature will not inhibit the normal operation of the controller. To unlock the display, the user will be prompted to enter in "EPCT".

5.4.27 Customer service contact

Allows the user to program specific contact information such as, the company name, contact person, phone number, and email address. The menu item will allow the programming of a password, separate from the menu password to protect this information from alterations. This information will be shown in the Help tab under Service Contact Information.

The service company can also set specific service message triggers to alert the end user that servicing is required. These notifications will show in the notification area on the Home tab.

5.4.27.1. Save configuration

Downloads a master configuration file. A simplified controller's configuration can be saved onto a USB drive. The configuration can then be used on other controllers that require the same configuration setup. The configuration will not adjust functionality settings.

Programming

5.4.27.2 Load configuration

Loads the master configuration file. A configuration file will be uploaded to the controller from a USB drive. The data located in the configuration file will change specific programmed setpoints in the controller.

5.4.28 Update firmware

If required, firmware can be updated using this menu item. Firmware needs to be obtained from the factory and will only be given to authorized service representatives.

5.4.29 Update languages

If required, languages can be uploaded using this menu item. Language files need to be obtained from the factory and will only be given to authorized service representatives.

5.5 Help tab

Refer to Appendix D for the menu structure of the Help tab

5.5.1 Product manual

A scannable QR code will be generated on screen to allow the user to download the IOM manual onto a mobile device.

5.5.2 Service contact information

The contact information for the Customer Service Contact will be shown on this screen.

5.5.3 Factory contact information

The contact information for the factory will be shown on this screen.

5.6 Pressure settings tab

Refer to Appendix E for the menu structure of the Pressure Settings tab

5.6.1 Start pressure

The value programmed determines at which pressure the controller will initiate a start sequence. The controller will start the pump when the measured pressure is equal to or less than this setting.

5.6.2 Stop pressure

Should the controller be programmed for automatic shutdown, the value programmed determines the system pressure must reach before the controller will automatically stop the fire pump motor in combination with the RPT elapsing. If the system pressure does not exceed the programmed Stop Pressure setpoint, the fire pump motor will continue to run.

5.6.3 Low pressure alarm

A low pressure alarm point can be selected that will be recorded in the controller's history and displayed in the notification area if enabled.

5.6.4 High pressure alarm

A high pressure alarm point can be selected that will be recorded in the controller's history and displayed in the notification area if enabled.

5.6.5 Start above pressure

The value programmed determines at which pressure the controller will initiate a start sequence. The controller will start the pump when the pressure is equal to or greater than this setting.

5.6.6 Pressure variance recording

A pressure setting may be selected, such that any change in pressure greater than this setting, will record the pressure fluctuation in the controller's history.

5.6.7 Hourly pressure recording

The controller can be set such that it will record a pressure reading every hour on the hour.

5.6.8 Low suction shutdown

The controller can be programmed to shutdown when a low suction condition is present. If this is desired, the user will select Enabled. There will also be a shutdown delay timer built in (Range: 0-99 Seconds, Default: 0 seconds) along with the selection of either a Manual or Automatic reset. If Manual Reset is selected, the "Press to Reset All Conditions" in the notification area must be activated to reset the alarm. If Automatic Reset is selected (default reset mode), a delay timer (Range: 0-99 Seconds, Default: 0 Seconds) must be set. Once the input is closed, the controller will start the Low Suction Delay timer. When the timer expires, if the input for Low Suction is still closed, the controller will shutdown the motor. When the input has cleared, the controller will initiate the reset timer. After the reset timer has elapsed, the controller will resume automatic operation. All timers will be displayed in the notification area. Low Suction Shutdown will have no affect on Local Starts, Remote Manual Starts, or Emergency Starts.

ATTENTION

Nfpa 20 specifically prohibits the installation of any device in the suction piping that will restrict starting or stopping of the fire pump. Eaton assumes no liability when this function is used.

5.6.9 Low foam shutdown

The controller can be programmed to shutdown when a low foam condition is present. If this is desired, the user will select Enabled. There will also be a shutdown delay timer built in (Range: 0-99 Seconds, Default: 0 seconds) along with the selection of either a Manual or Automatic reset. If Manual Reset is selected, the "Press to Reset All Conditions" in the notification area must be activated to reset the alarm. If Automatic Reset is selected (default reset mode), a delay timer (Range: 0-99 Seconds, Default: 0 Seconds) must be set. Once the input is closed, the controller will start the Low Foam Delay timer. When the timer expires, if the input for Low Foam is still closed, the controller will shutdown the motor. When the input has cleared, the controller will initiate the reset timer. After the reset timer has elapsed, the controller will resume automatic operation. All timers will be displayed in the notification area. Low Foam Shutdown will have no effect on Local Starts, Remote Manual Starts, or Emergency Starts.

ATTENTION

Nfpa 20 specifically prohibits the installation of any device in the suction piping that will restrict starting or stopping of the fire pump. Eaton assumes no liability when this function is used.

5.6.10 Proof pressure switch

An external pressure switch can be activated on one of the inputs. Enabling this feature requires that the programmed input for Proof Pressure Switch is closed to allow the FPC to start the motor.

5.6.11 Pressure units

The user can select which pressure unit of measure is to be displayed. The units can be programmed for PSI, BAR, or kPa.

5.6.12 Pressure transducer

Some applications do not require a pressure sensor to sense the system pressure in order to start the pump motor when required. In order to accomplish this, the pressure sensor can be disabled through this menu item. Once disabled, the pressure start point, pressure stop point, low pressure alarm, and high pressure alarm set-points will be removed from the menu system. Refer to 4.3 for the Remote Auto Start input to use instead of the pressure sensor.

5.6.13 Calibrate transducer

The controller allows for three (3) different forms of calibration.

Full Calibration requires the system to be reduced to a known value, typically 0 psi. This value is then entered into the controller. The system pressure is then increased to a higher known value which is also entered into the controller.

Calibrate Using Current Pressure is a partial calibration. The low pressure point is assumed to be correct. The high point is adjusted based on the actual system pressure.

Reset to Factory Default resets the transducer calibration to the original factory settings.

5.7 Timer values tab

Refer to Appendix F for the menu structure of the Timer Values tab

5.7.1 Minimum run time (RPT)

The minimum run timer is used to automatically stop the controller after a programmed time. The timer will start timing once the pump has reached a running condition. If Automatic Shutdown is disabled, the RPT will not be active. It will not start on Remote Manual Starts, Local Starts, and Emergency Starts. While it is timing the amount of time left on the timer will be displayed in the notification area.

5.7.2 Acceleration timer (AT)

The acceleration timer can be programmed to allow the controller to run in a reduced voltage state for a period of time. This timer will start timing once a start signal has been received and the startup relay has energized.

5.7.3 Sequential start time

The sequential start timer can be set to delay the starting of the pump when a automatic starting condition exists. If, during the timing of the sequential timer, the pressure rises above the pressure start point, the timer will stop timing and the starting sequence will discontinue. When the SST is timing, the time left will be displayed in the notification area. The SST will not work on Remote Manual Starts, Local Starts, and Emergency Starts.

5.7.4 Fail to start timer (FTS)

The controller determines that the motor is successfully running when, at least, 20% of the programmed motor full-load current has been reached. If the controller initiates a start sequence, manual or automatic, and the calculated current has not reached 20% of the motor full-load current after the Fail To Start timer has timed out, the Fail to Start alarm will be generated.

5.7.5 Fail to stop timer

The controller determines that the motor has successfully stopped when the calculated current has dropped below the 20% threshold after a call-to-stop was initiated. If the controller initiates a stop sequence, manual or automatic, and the calculated current has not dropped below 20% of the motor full-load current after the Fail To Stop timer has timed out, the Fail to Stop alarm will be generated.

Programming

5.7.6 Weekly motor test timer

A Weekly Motor Test Timer can be programmed that will automatically start and run the fire pump motor at specific intervals. The Weekly Timer is set by adjusting the day, hour, and minute of the desired weekly run time, the length of time that this test shall be performed, and a test interval (in weeks). While the weekly test timer is timing, the remaining time will be displayed in the notification area.

5.8 Alarm setpoints tab

5.8.1 Phase reversal

The user will be able to change the Phase Reversal setpoint that the controller will base the Phase Reversal alarm on.

5.8.2 Phase failure alarm setpoint

The Power/Phase Failure alarm will activate if the voltage of one phase is lower than the highest phase by the percentage programmed.

5.8.3 Motor overload setpoint

Motor Overload alarm will activate if the amperage draw is exceeding the amount programmed for a period greater than eight (8) seconds.

5.8.4 Transducer fail pump start

Transducer Failure is defined as the transducer reading is lower than 4mA or greater than 20mA. If this setting is enabled and the transducer reading is out of the allowable range, the controller will start the motor and alarm for Transducer Failure.

5.8.5 Abort motor test on low voltage

When enabled, this will cause the controller to abort the motor test when a under voltage condition is detected. This will impact both the weekly and manual motor tests.

5.8.6 Voltage alarm settings

This menu item allows the user to adjust voltage dropout and pickup settings. Should the controller be equipped with an ATS, the screen will provide the ability to have different setpoints for either Source.

5.8.7 Frequency alarm settings

This menu item allows the user to adjust frequency dropout and pickup settings. Should the controller be equipped with an ATS, the screen will provide the ability to have different setpoints for either Source.

5.9 Inputs/outputs tab

5.9.1 Inputs

The optional inputs have the ability to be programmed for predetermined values or custom values. The Input menu will display each input, what it is programmed for, allow a delay to be programmed, allow the input to latch when the input signal is received, program the input to be fail safe (if enabled, the contact will be considered normally closed) and link the notification area virtual lights to the input. Refer to Table 2 Generic Custom Input Labels for the generic values the optional inputs can be programmed for. When this input is received a message will be stored in memory using the programmed label. The input can be linked to the common alarm in under Panel Setup menu.

Table 2

Programmable input alarms

Remote Manual Start
Remote Manual Stop
Remote Manual Start/Stop
Remote Auto Start
Deluge Valve Start
Low Suction
Low Foam Level
Proof Pressure Switch
Low Room Temp
High Room Temp
Low Reservoir
High Reservoir
Interlock
Go to Source 1
Go to Source 2
Enable Sequential Start
Custom Input
Undefined

5.9.2 Outputs

The optional output relays can be programmed to operate based on the desired function. The Custom Output menu will display each output, what it is programmed for, allow a delay to be programmed, allow the output to latch when the relay is energized, and program the output for fail safe (if enabled, the relay will be normally energized). Please refer to Table 3 for the generic values the optional outputs can be programmed for.

Table 3

Programmable output alarms
Startup
Acceleration
Pressure Below
Pressure Above
Common Alarm
Engine Start Contacts
Power ON
Pump Running
Local Start
Emergency Start
Below Start Pressure
Start Above Pressure
Low Pressure Alarm
High Pressure Alarm
Remote Manual Start
Remote Auto Start
Deluge Valve Start
Hardware Fault
Transducer Failure
Motor Overload
Low Reservoir
High Reservoir
Low Room Temp
High Room Temp
Low Suction
Low Foam Level
Fail to Start
Fail to Stop
Load Shed
Input 1
Input 2
Input 3
Input 4
Input 5
Input 6
Input 7
Input 8
Input 9
Input 10
Engine Test Run
Engine Test Fail
Motor Test Run
Motor Test Fail
ATS Transfer Failure
Source 2 Disconnected
S1 Available

Programmable output alarms

S2 Available
S1 Phase Failure
S2 Phase Failure
S1 Under Voltage
S2 Under Voltage
S1 Over Voltage
S2 Over Voltage
S1 Under Frequency
S2 Under Frequency
S1 Over Frequency
S2 Over Frequency
S1 Phase Reversal
S1 Phase Reversal
ATS Connected to S1
ATS Connected to S2
Disabled

5.10 History stats diag. Tab (history statistics diagnostics)

5.10.1 Message history

The EPCT controller will record a number of items in its memory to assist with troubleshooting of the system and/or the fire pump controller. The controller will record up to 65,000 alarm/status messages in its memory that can be viewed on the main display or saved to a USB storage device. Up to ten (10) events can be viewed on the Message History screen. Event dates and times are also displayed.

Pressing the Up or Down arrow buttons will advance through messages saved in the memory one at a time.

Pressing the Page up or Page down arrow buttons will advance through messages saved in the memory 10 messages at a time.

Pressing and holding the Up, Down, Page Up or Page Down arrows, allows the messages to scroll continuously through all messages saved in the memory; scrolling speed increases the longer the button is held for .

Message History data is stored in a comma separated value (CSV) format.

5.10.2 Controller statistics

The EPCT controller will record several statistical values that can be viewed on the main display or saved onto a USB storage device. The statistics can be cleared by pressing the “Clear All Controller Statistics” button. Please refer to Table 4 for the statistical values that are recorded.

Programming

Table 4

Statistics
Total Powered Time
Total Motor Run Time
Last Motor Run Time
Calls to Start
Motor Starts
Maximum Starting Current A
Maximum Starting Current B
Maximum Starting Current C
Maximum Run Current A
Maximum Run Current B
Maximum Run Current C
Last LR Voltage A
Last LR Voltage B
Last LR Voltage C
Last LR Current A
Last LR Current B
Last LR Current C
Minimum System Pressure
Maximum System Pressure
Minimum S1 Voltage AB
Minimum S1 Voltage BC
Minimum S1 Voltage CA
Maximum S1 Voltage AB
Maximum S1 Voltage BC
Maximum S1 Voltage CA
Minimum S2 Voltage AB
Minimum S2 voltage BC
Minimum S2 Voltage CA
Maximum S2 Voltage AB
Maximum S2 Voltage BC
Maximum S2 Voltage CA
Minimum S1 Frequency
Maximum S1 Frequency
Minimum S2 Frequency
Maximum S2 Frequency
Last System Startup
Last Motor Start
Last Low Pressure Start
Last Locked Rotor Trip
Last S1 Phase Failure
Last S2 Phase Failure
Last S1 Phase Reversal
Last S2 Phase Reversal
Last S1 Overvoltage
Last S1 Under voltage
Last S2 Under voltage
Last S2 Overvoltage
Last S1 Under frequency
Last S2 Over frequency
Last S1 Under frequency

Statistics

Last S2 Over frequency
Last Generator Start
Last Generator Stop
Last Transfer to S1
Last Transfer to S2
Last S2 Disconnect

5.10.3 Controller diagnostics

The EPCT controller will display a number of diagnostic values that can be viewed on the main display or saved onto a USB storage device.

The main diagnostic page will display the firmware version, voltages, amperages, and transducer information.

The input status page will display the state of each input contact. Pressing the input buttons, the controller will override the state of that input for one minute. If the button is depressed a second time, the input will resume normal operation. If the screen is exited, the input will resume normal operation.

The output status page will display the state of each output relay on the I/O board or ATS board (if equipped), solenoid valve, and alarm. Pressing the output buttons, the controller will override the state of that output for one minute. If the button is depressed a second time, the output will resume normal operation. If the screen is exited, the input will resume normal operation. The horn can be silenced for a period of ten (10) minutes that will not reset by leaving the screen.

The controller is equipped with on board communication diagnostics. The last page in the Controller Diagnostic menu allows the user to test the transfer and receive functions of the display board. The screen will provide a prompt that the test successfully passed or failed.

5.10.4 Startup information

The EPCT controller will log all tasks that are completed/programmed through the STARTUP tab in a separate file. This allows the user to specifically identify all completed activities during the startup/commissioning process.

5.10.5 Save to USB

Data can be saved to an external USB memory device via the USB port located on the controller door. When a valid USB device is inserted, the button text will change from "INSERT USB" to "PRESS TO SAVE". Once the data has been saved to the USB, the display will prompt the user to remove the USB device.

Message history, statistics, diagnostics, configuration, and the startup file will be saved onto the USB in comma separated value (CSV) format.

6.0 Automatic transfer switch (ATS)

6.1 General

Transfer switches are used to protect critical electrical loads against loss of power. The load's Source 1 power source is backed up by a Source 2 power source. A transfer switch is connected to both the Source 1 and Source 2 power sources and supplies the load with power from one of the two sources. In the event that power is lost from Source 1, the transfer switch transfers the load to the Source 2 power source. Once Source 1 power is restored the load is automatically transferred back to the Source 1 power source.

The transfer switch will transfer to the backup source when the Source 1 power falls below or rises above a pre-set voltage, frequency, or in the event of a phase reversal. If the Source 2 power source is a standby generator the ATS will initiate a generator start up. It will then transfer to the Source 2 power source once sufficient generator voltage is available. When Source 1 power is restored the ATS automatically transfers back to the Source 1 and will initiate a generator engine shutdown.

The transfer switch has four basic elements:

1. **Main contacts** that connect and disconnect the load from the Source 1 and Source 2 supplies.
2. The **ATS electrical control** circuit that energizes the transfer mechanism to switch the main contacts.
3. The **mechanical transfer mechanism** that switches the main contacts.
4. The **ATS control board and touchscreen display** that monitor the condition of the power sources and provide intelligent decisions for the the operation of the transfer switch.

6.2 Main contacts

The connection of the ATS load to either of the two source supplies is managed through a pair of isolation switches. The normal isolation switch controls Source 1 while the emergency isolation switch controls Source 2. The mechanical assembly that operates the isolation switches is designed to prevent both sources from feeding the load at the same time. The fire pump controller I/O board and the ATS control board monitor the source 1 and source 2 voltages at the line side of the isolation switches. A set of auxiliary switches installed in each of the isolation switches provide positional feedback to the ATS controller on which source is currently supplying the load. These auxiliary switches are connected to terminal 68 (common), 70 (ATS Normal), and 71 (ATS Emergency). If the ATS is in the Source 1 position then terminal 68 and 70 will be closed and 68 and 71 will be open. If the ATS is in the Source 2 position then terminal 68 and 71 will be closed and 68 and 70 will be open.

6.3 ATS electrical control circuit

When the ATS control board initiates a transfer to Source 2 or Source 1 it will energize the 9CR relay located on the ATS control board. Energizing this relay will result in closure of the contact between terminals 72 & 73 on the ATS board. Closing this contact will energize the ATS motor and the motor brake. The motor is supplied power from one of two 120Vac secondary control power transformers supplied by Source 1 and Source 2. The control power transformer primary voltage is derived from the line side of the ATS isolation switches. The transformers provided in the assembly will depend on the line voltage of the customer's application. To prevent the transformers from back feeding one another a factory supplied relay (KV) is used to isolate the transformers from each other. This KV relay will energize whenever Source 2 is present.

6.4 Mechanical transfer mechanism

The smaller transfer switch controllers that use the F-Frame (150A) isolation switches have the fire pump controller and transfer switch located in the same enclosure. The transfer switch portion of the controller is separated from the rest of the fire pump controller using a white, metal barrier. A beam mechanism connects the isolation switch handles and the motor operator arm. The beam attaches to a mounting plate at a pivot point located between the isolation switches. The motor operator arm rides in a track at the other end of the beam. As the motor arm rotates the beam pivots on its mount causing the normal and emergency isolation switch handles to move up or down. This will connect or disconnect Source 1 and 2. At no time will both the normal and emergency sources be connected at the same time. To manually rotate the motor, you must first de-energize the controller. The motor is located behind the operator arm on the mechanism mounting plate. Locate the clutch plate on the bottom of the motor towards the back of the enclosure. It is a rectangular, gold coloured plate that has a small amount of movement. Press and hold the clutch plate to the motor frame. You will now be able to rotate the motor arm to move the position of the beam.

The larger transfer switch controllers that use the K-Frame (300A or 400A), L-Frame (600A), or N- Frame (800A or 1200A) isolation switches have the transfer switch located in a separate enclosure. The separate enclosure is bolted directly to the fire pump controller enclosure. The transfer switch has a rotating metal handle and an arrow which indicates the position of the transfer switch (normal/emergency/neutral). The ATS motor operator mechanism is located behind the manual operator handle and cover plate. The motor operator mechanism connects to the handles of the isolation switches. As the motor operator mechanism or manual operation handle rotates the normal and emergency isolation switches connect and disconnect. At no time will both the normal and emergency sources be connected at the same time. To manually operate the transfer switch, you must first de-energize the controller. After it is de-energized you may manually rotate the handle until the arrow aligns to the desired transfer switch position.

Automatic transfer switch (ATS)

6.5 ATS control board & touchscreen display

The ATS control board is connected to the main fire pump controller I/O board by a ribbon cable. Through this cable it is able to receive and send both power and control signals necessary for proper controller and ATS operation when supplied by either source. The ATS board is also provided with terminations for a number of important inputs and outputs specific to the ATS functionality.

6.5.1 Inputs

- Source 2 Input Supply Voltage
Supplies Source 2 power to the ATS board and the I/O board when Source 1 is absent.
- Source 2 Isolating Switch is in the OFF Position
Feedback from the auxiliary switch located in the Source 2 MIS to indicate if the disconnect is in the open or closed position.
- ATS is in the NORMAL Position
Feedback provided by the auxiliary switch located in the Source 1 ATS isolation switch that shows if the isolation switch is in the open or closed position.
- ATS is in the EMERGENCY Position
Feedback provided by the auxiliary switch located in the Source 2 ATS isolation switch that shows if the isolation switch is in the open or closed position.

6.5.2 Outputs

- Emergency source circuit breaker shunt trip connection.
Provides a signal to the Source 2 circuit breaker shunt trip mechanism to trip the breaker in the event of a locked rotor level current event.
- Source 2 Disconnected.
The 7CR relay is used to provide indication of the status of the Source 2 MIS. When the Source 2 MIS is turned to the OFF position the relay will activate.
- Engine start contacts.
The 8CR relay provides a contact that will activate during power loss or when Source 1 power becomes unavailable. 8CR relay is wired to terminals 51 and 52 located in the ATS section/cabinet.
- Transfer motor/brake control.
When there is a call to transfer, the 9CR relay will energize to start the ATS motor.

6.5.3 Touchscreen display ATS graphics

The home page on the touchscreen display will show the position of the transfer switch. When the ATS is in the Source 1 position the single line graphic on the display will show the Source 1 ATS contact closed and the Source 2 ATS contact open. When in the Source 2 position the single line graphic on the display will show the Source 2 ATS contact closed and the Source 1 ATS contact open. When the transfer switch is in the neutral position both the Source

1 and Source 2 ATS contacts will show open. If the MIS for Source 2 is open a visual and audible alarm for the Source 2 Disconnect should appear and the single line graphic on the display will show the EMER. DISC contacts as open.

6.6 Programming

Refer to Appendix G for the menu structure of the ATS

6.6.1 Time delay S1 to S2

This feature provides a time delay when transferring from Source 1 to Source 2. The timer starts when the controller detects that Source 2 becomes available.

6.6.2 Time delay S2 to S1

This feature provides a time delay when transferring from Source 2 to Source 1. The timer starts when the controller detects that Source 1 becomes available.

6.6.3 Time delay neutral

When enabled, the transfer switch will stop in neutral position (both breakers are in the open/disconnected position) and wait until the TDN timer expires. Once the timer expires, the transfer switch will complete the transfer to the target source.

6.6.4 Time delay engine start

The timer, if enabled, delays the starting of the backup generator until the timer has elapsed. This is typically used to prevent nuisance generator starting should minor voltage fluctuations occur.

6.6.5 Time delay S2 fail

This feature provides a time delay to alarm that Source 2 (generator) failed to start as full voltage was not registered on the Source 2 input.

6.6.6 Time delay engine cooldown

This feature provides a time delay of the signal to initiate the engine/generator stop cycle after the controller transferred back to Source 1. This allows the engine/generator to cool down by running unloaded. Timing begins when the controller successfully transfers back to Source 1.

6.6.7 Dual utility

This feature allows the controller to be programmed for a dual utility system. When enabled, the controller will alarm should the voltage on either source be disrupted. The user will be given an option to program a preferred source. The preferred source will be the source that the controller will default to should both power sources be viable.

6.6.8 Weekly engine test timer

A Weekly Engine Test Timer can be programmed that will automatically start and run the generator at specific intervals. The Weekly Timer is set by adjusting the day, hour, and minute of the desired weekly run time, the length of time that this test shall be performed, a test interval (in weeks), and the ability to transfer the load to Source 2. While the weekly test timer is timing, the remaining time will be displayed in the notification area.

Refer to section 5.8 and Appendix G.

Optional add-on boards

7.0 Optional add-on boards

The EPCT controller is available with four (4) additional option cards: Relay Board, Secondary 4-20mA Device, MODBUS, and an Alarm Option board. The EPCT will have the capability to have future option boards installed with the use of a firmware update. The maximum allowable current through the relays is 8A 250VAC / 30VDC.

When a card is installed, the programming tab for the board will become visible. Programming values will be retained on option card.

7.1 Relay output board

It includes four (4) relays with (1) one set of form C contacts per relay wired to terminal blocks. The relays shall be rated at 8A, 250VAC and 30VDC. It includes two (2) pull-apart six (6) pin terminal blocks.

7.1.1 Programming

- i. Refer to Appendix K.

7.2 Secondary 4-20 mA device

It includes a two (2) pole 4-20 mA input screw type, pull-apart terminal block. It also contains four (4) relays with (1) set of form-C contacts per relay wired to terminal blocks. The relays shall be rated at 8A, 250VAC and 30 VDC and it includes two (2) pull-apart six (6) pin terminal blocks.

7.2.1 Programming:

- i. Refer to Appendix L.

7.3 MODBUS Board

It includes an eight (8) pole dip switch bank designed to switch between RS422 and RS485 with or without terminating resistors. Includes one (1) pull-apart six (6) pin terminal block for TXD0, TXD1, RXD0, RXD1, Common, and a blank terminal. Includes two (2) surface mount LED's, one (1) for transmitting and one (1) for receiving.

7.3.1 Programming:

- i. Refer to Appendix M.

7.4 Supervisory alarm option board

It includes a piezoelectric buzzer with a minimum of an 90dB rating. Includes one (1) pull-apart six (6) pin terminal block; two terminals are used for a 120VAC input (non-polarity specific), two terminals are used for an external 120VAC, minimum 50mA light connection, two terminal blocks are used for an external and silence push button.

7.4.1 Programming:

- i. Refer to Appendix N.

	SW1	SW2	SW3	SW4	SW5	SW6	SW7	SW8
RS422 Unterminated	OFF	OFF	OFF	OFF	OFF	OFF	OFF	OFF
RS422 Terminated RX	OFF	OFF	OFF	OFF	ON	ON	OFF	OFF
RS422 Terminated TX	ON	OFF	ON	OFF	OFF	OFF	OFF	OFF
RS422 Terminated RX/TX	ON	OFF	ON	OFF	ON	ON	OFF	OFF
RS485 Unterminated	OFF	ON	OFF	ON	OFF	OFF	OFF	OFF
RS485 Terminated	ON	ON	ON	ON	OFF	OFF	OFF	OFF

Appendix A: menu structure

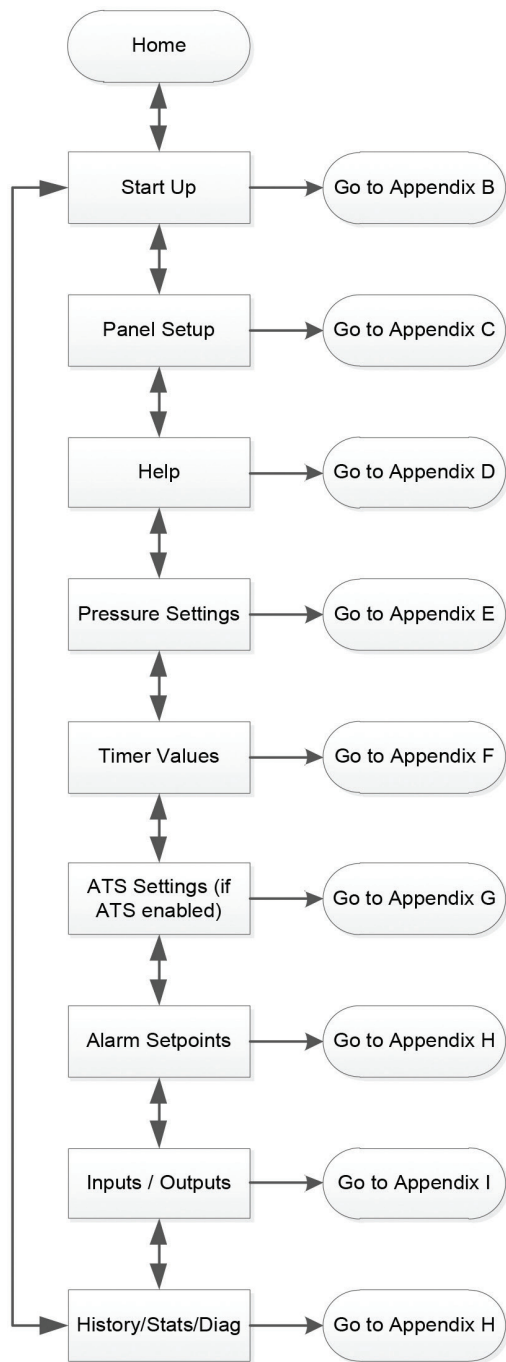

Note: Pressing the Back or Cancel button when available will return the screen to the previous option.

Appendix B: startup tab menu structure

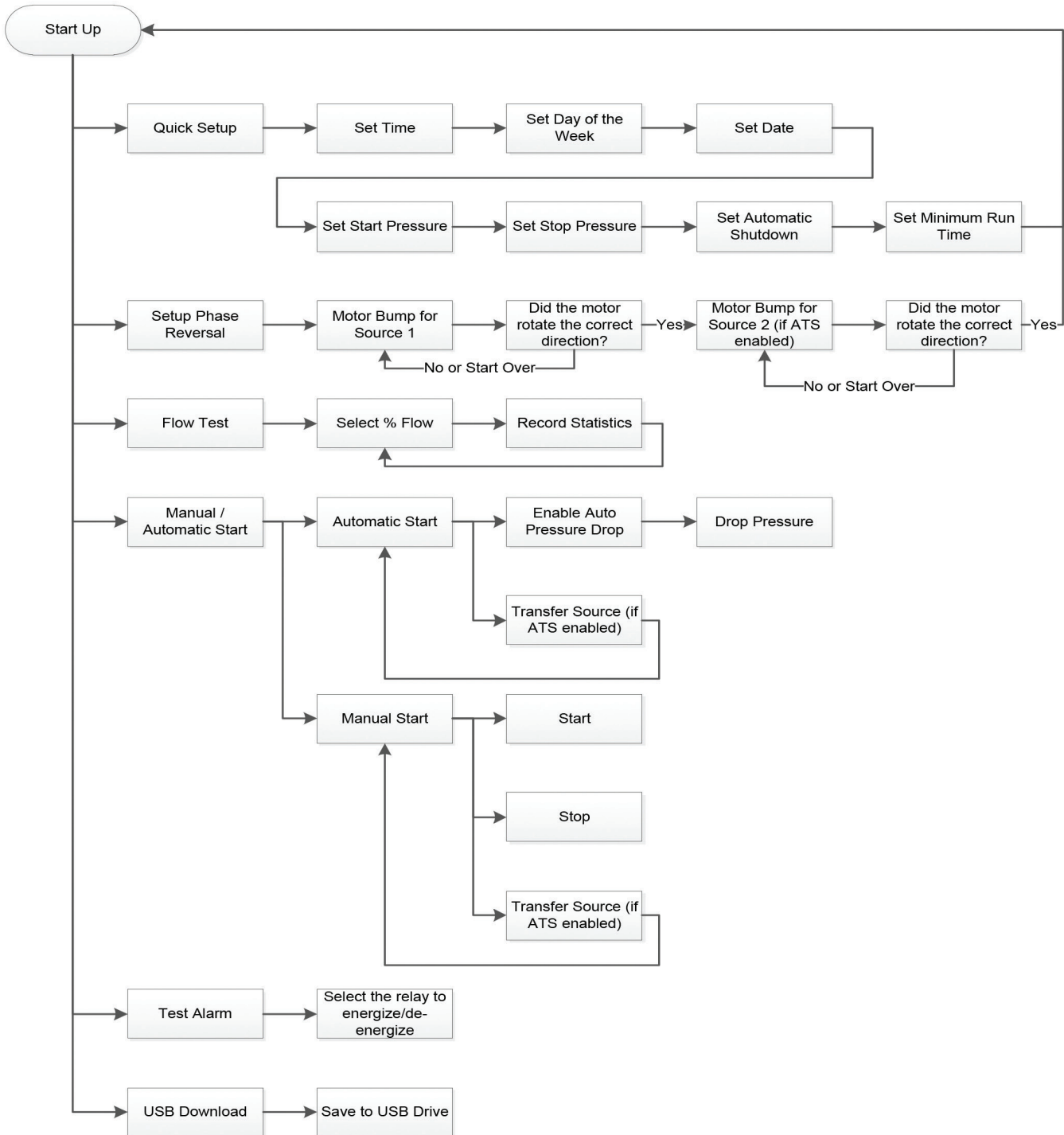

Note: Pressing the Back or Cancel button when available will return the screen to the previous option.

Appendix C (a): panel setup tab menu structure

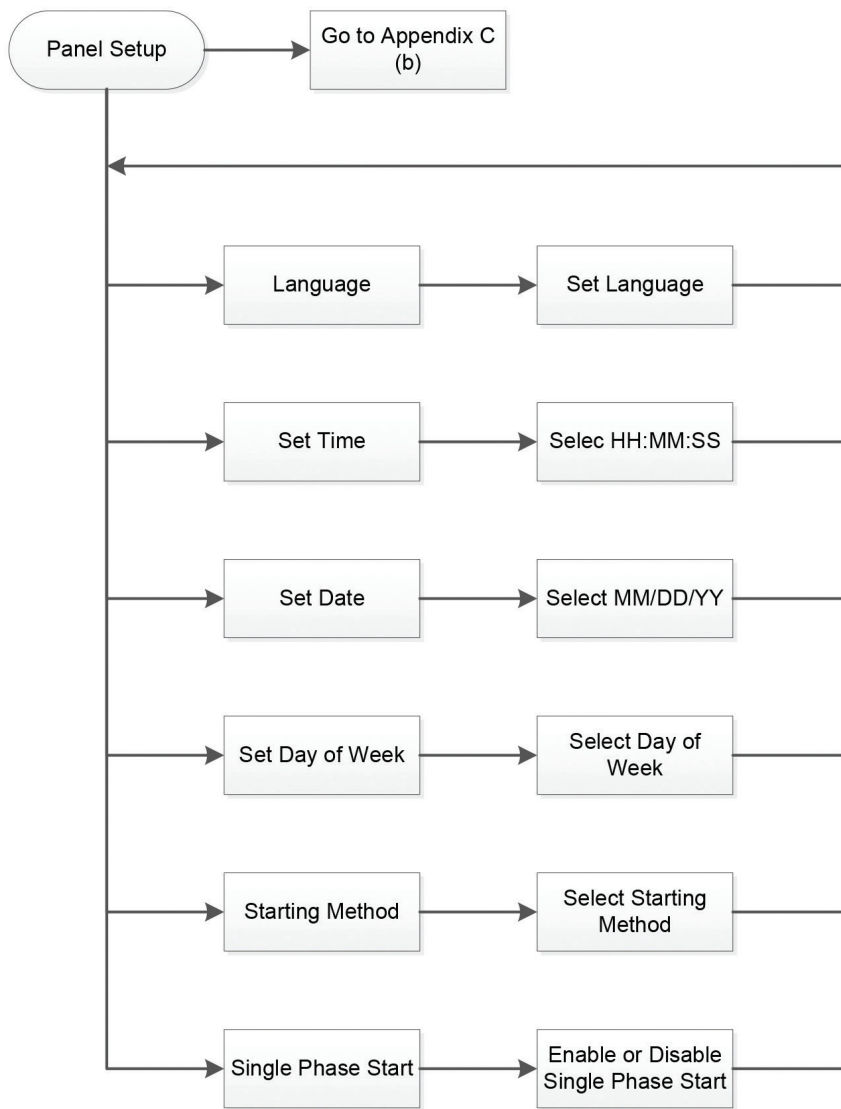

Note: Pressing the Back or Cancel button when available will return the screen to the previous option.

Appendix C (b): panel setup tab menu structure continued

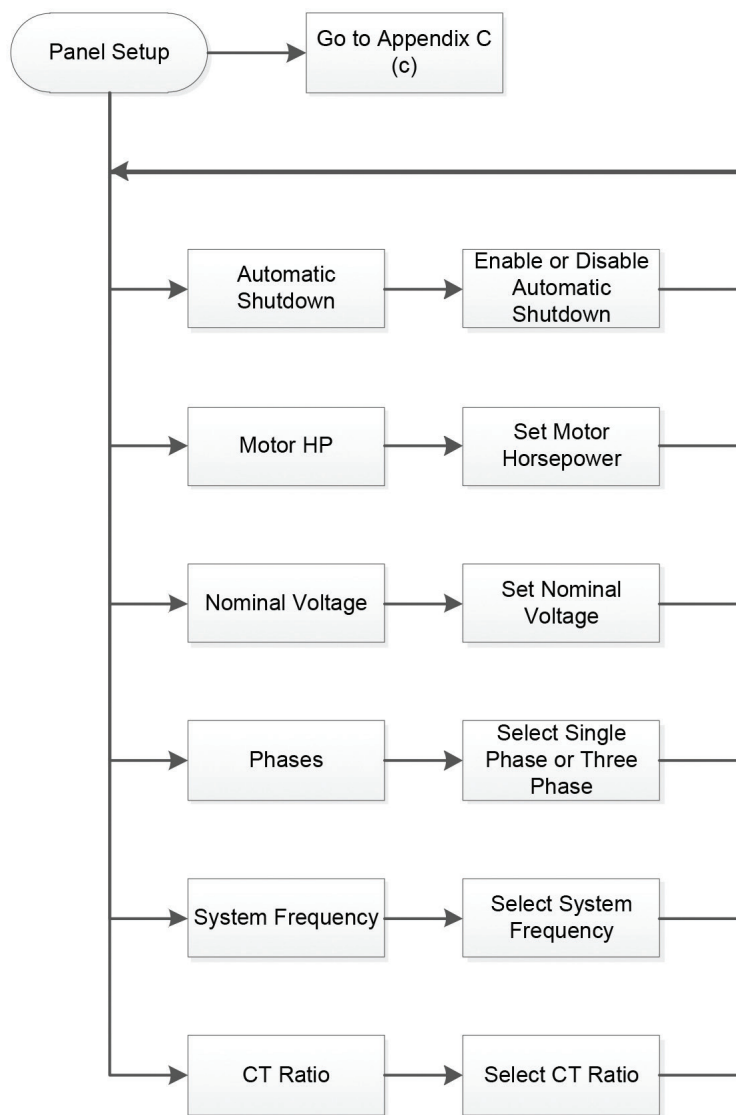

Note: Pressing the Back or Cancel button when available will return the screen to the previous option.

Appendix C (c): panel setup tab menu structure continued

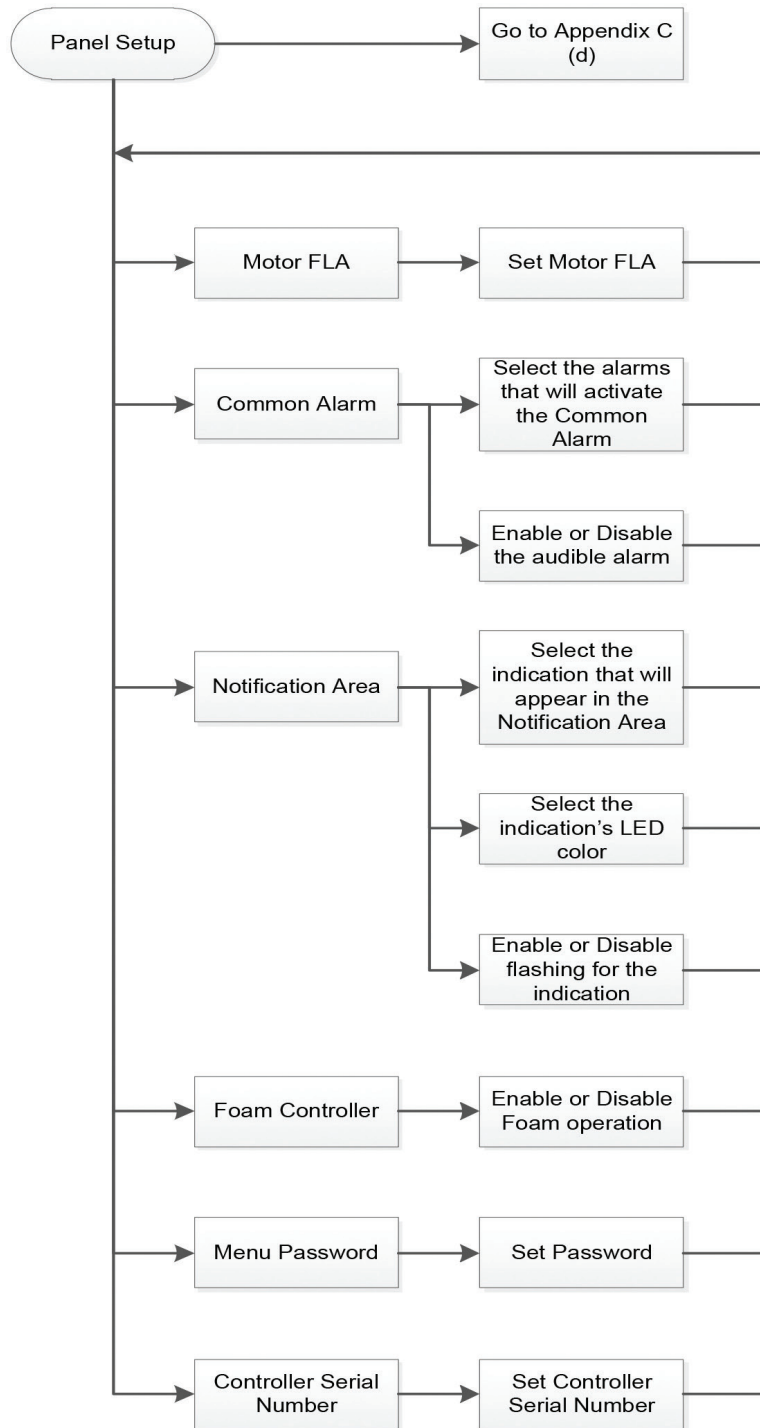

Note: Pressing the Back or Cancel button when available will return the screen to the previous option.

Appendix C (d): panel setup tab menu structure continued

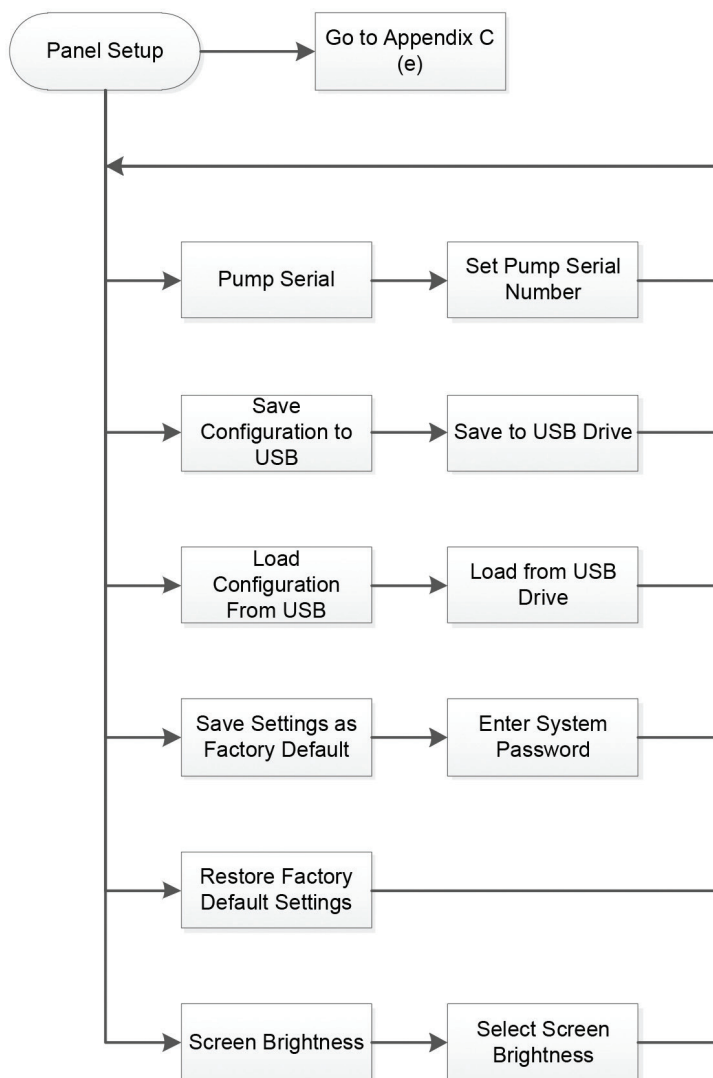

Note: Pressing the Back or Cancel button when available will return the screen to the previous option.

Appendix C (e): panel setup tab menu structure continued

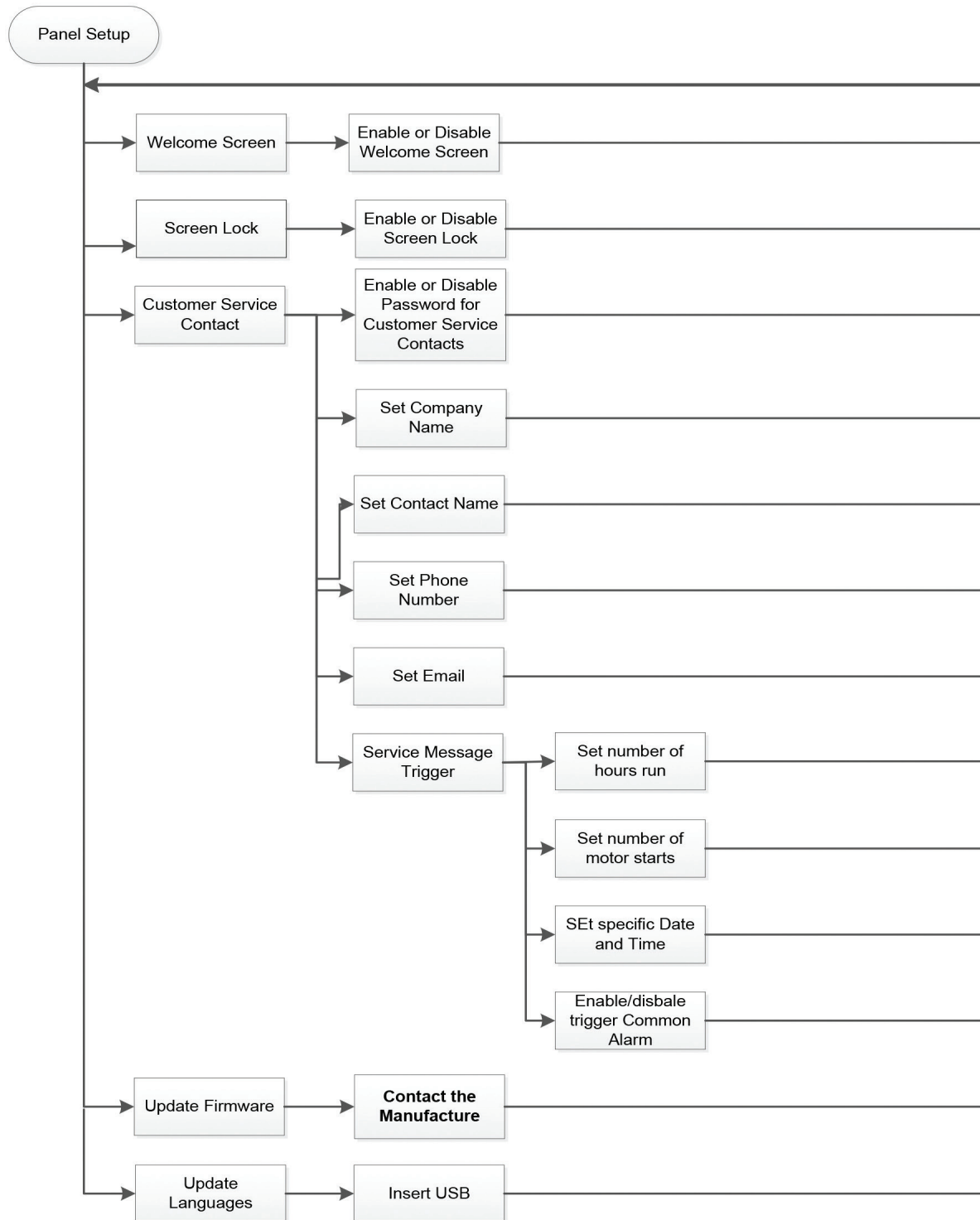

Note: Pressing the Back or Cancel button when available will return the screen to the previous option.

Appendix D: help tab menu structure

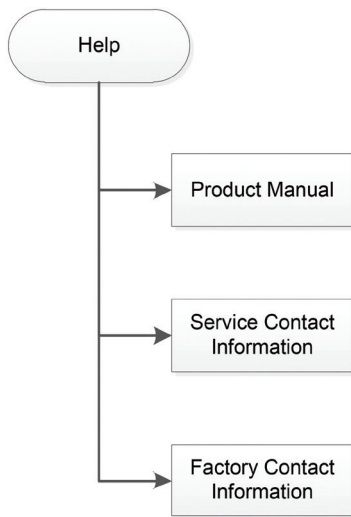

Note: Pressing the Back or Cancel button when available will return the screen to the previous option.

Appendix E (a): pressure settings tab menu structure,

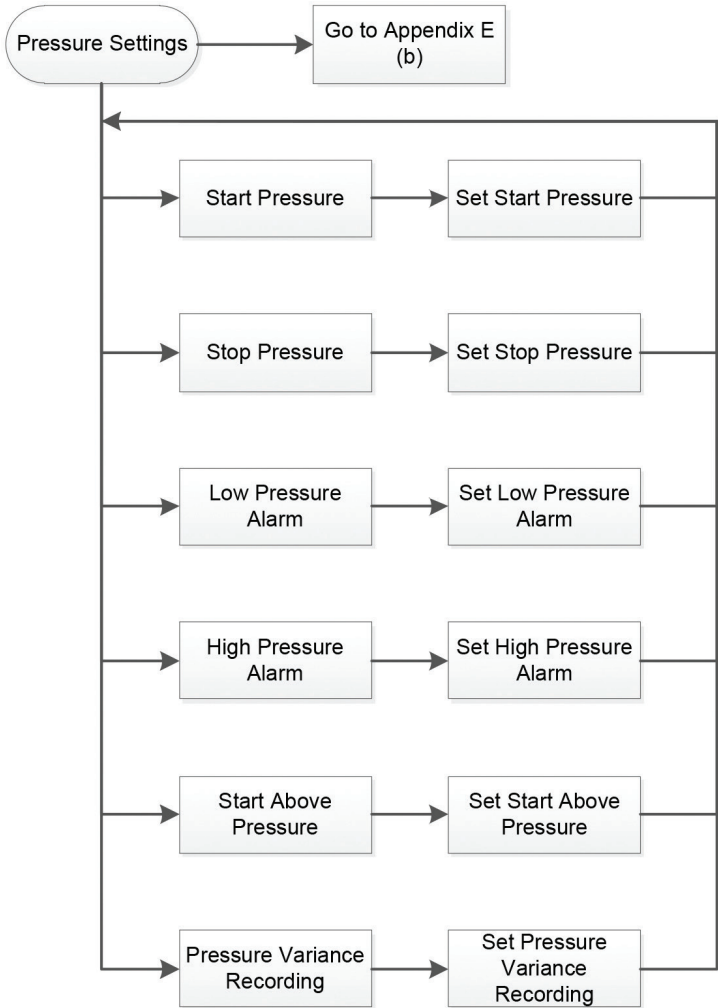

Note: Pressing the Back or Cancel button when available will return the screen to the previous option.

Appendix E (b): pressure settings tab menu structure continued,

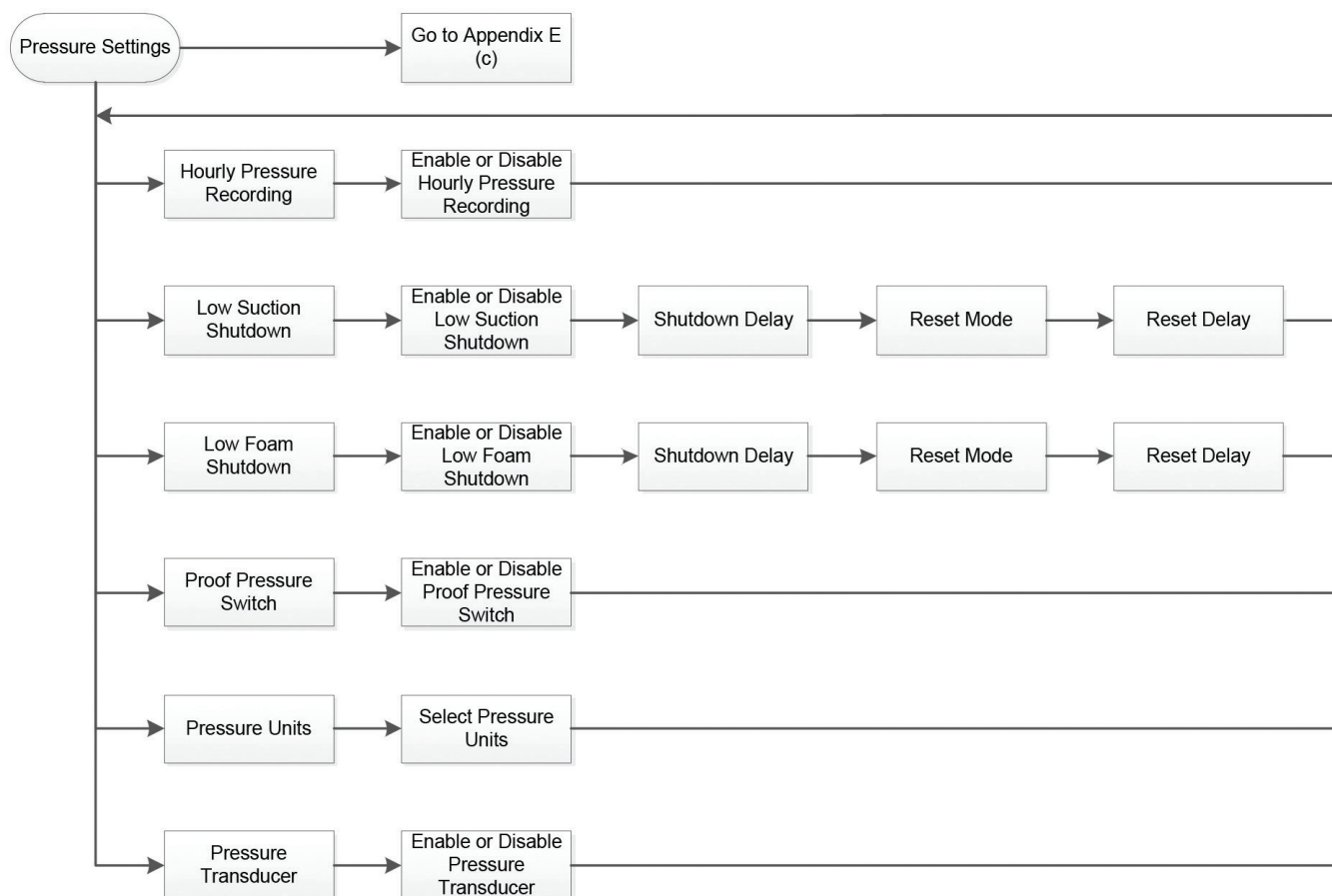

Note: Pressing the Back or Cancel button when available will return the screen to the previous option.

Appendix E (c): pressure settings tab menu structure continued

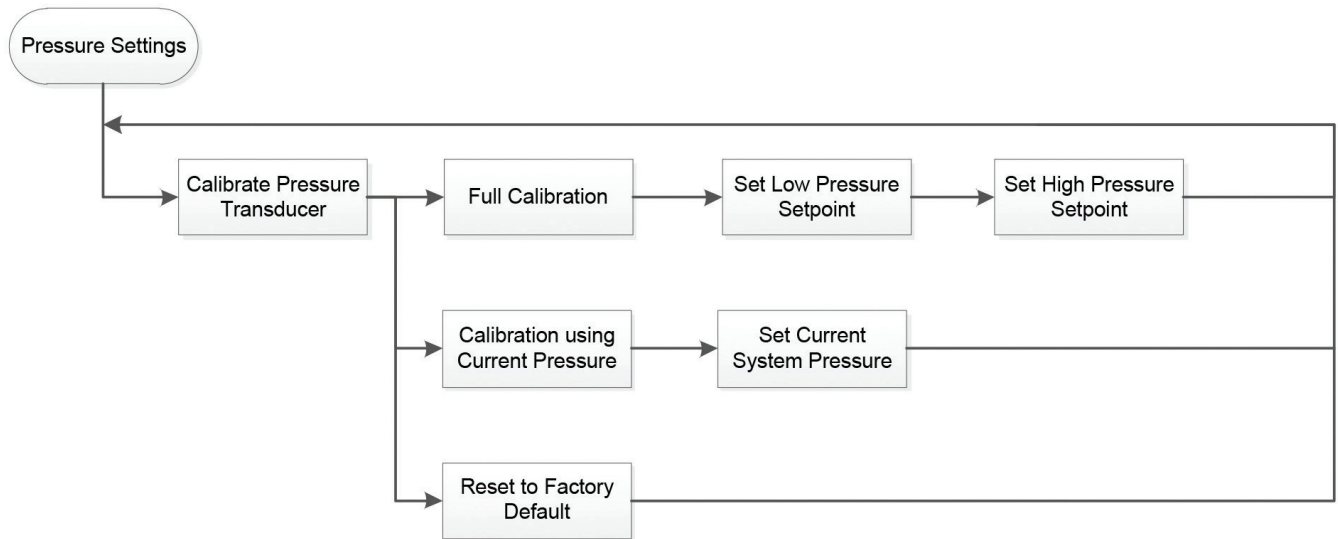

Note: Pressing the Back or Cancel button when available will return the screen to the previous option.

Appendix F: timer values tab menu structure

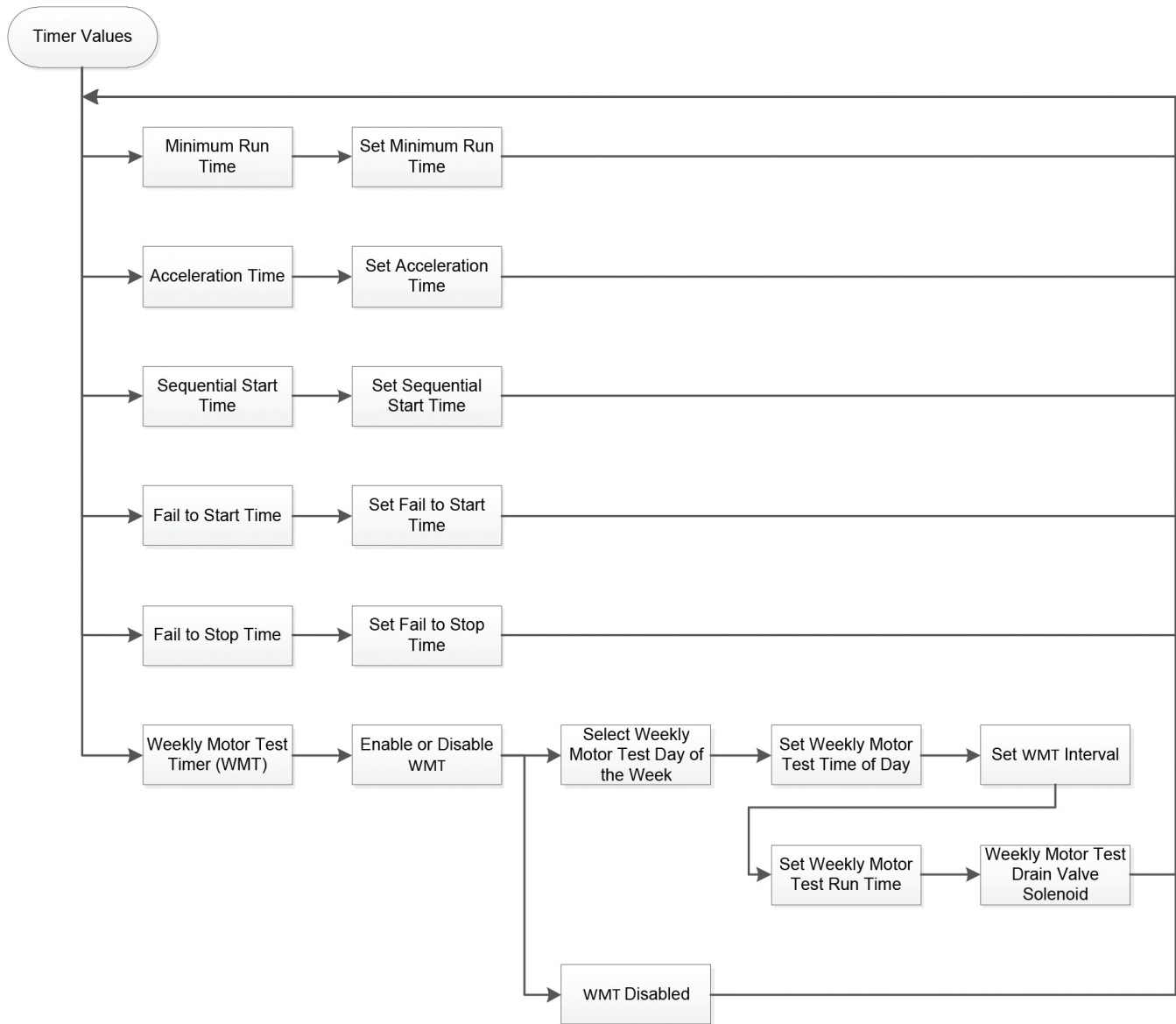

Note: Pressing the Back or Cancel button when available will return the screen to the previous option.

Appendix G (a): ATS settings tab menu structure

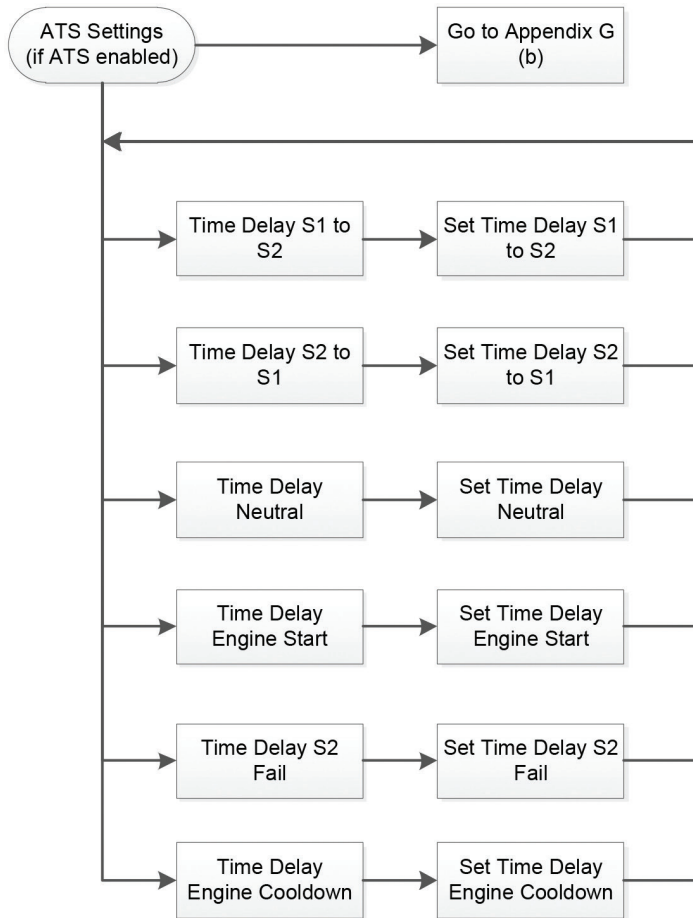

Note: Pressing the Back or Cancel button when available will return the screen to the previous option.

Appendix G (b): ATS settings tab menu structure continued

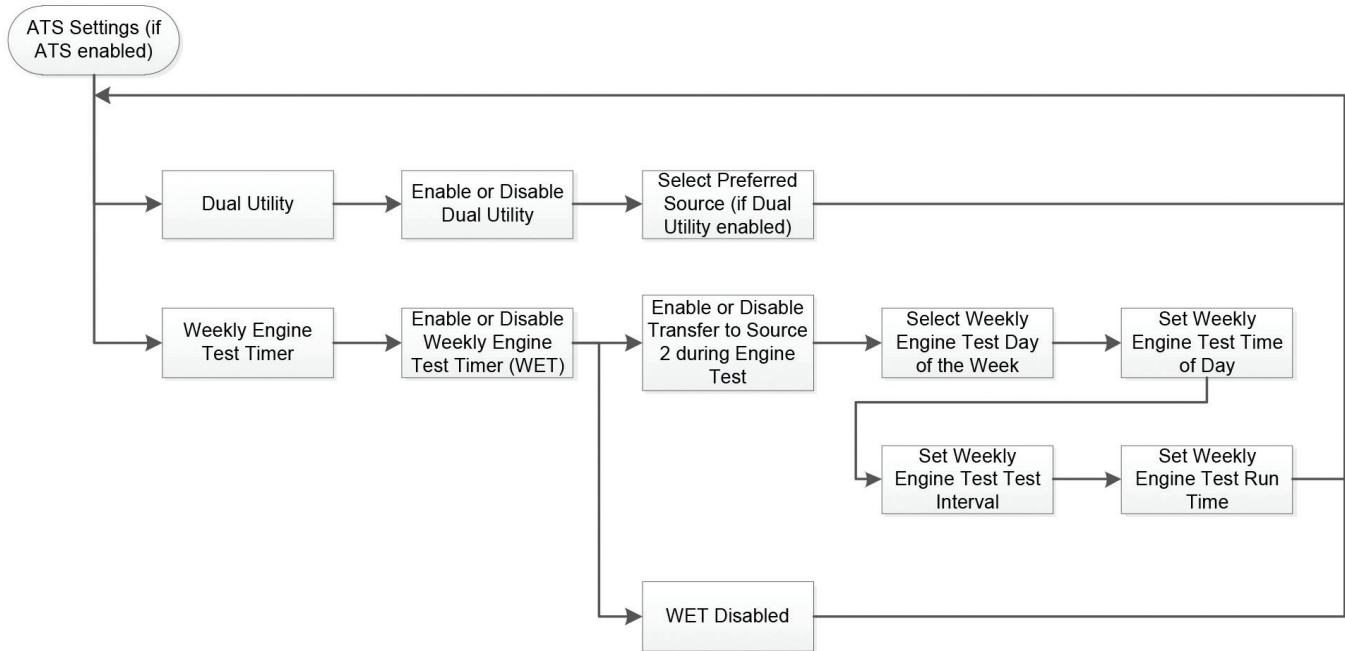

Note: Pressing the Back or Cancel button when available will return the screen to the previous option.

Appendix H (a): alarm setpoints tab menu structure

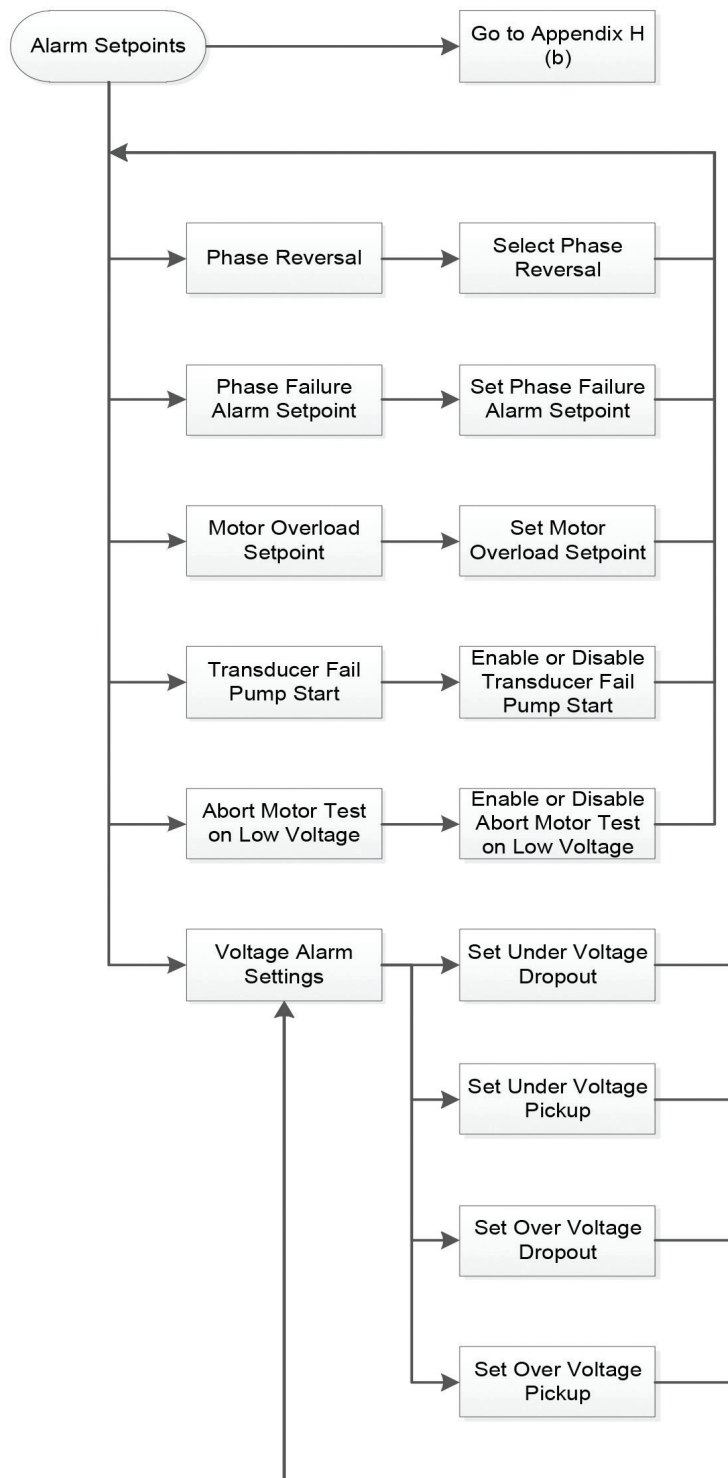

Note: Pressing the Back or Cancel button when available will return the screen to the previous option.

Appendix H (b): alarm setpoints tab menu structure continued

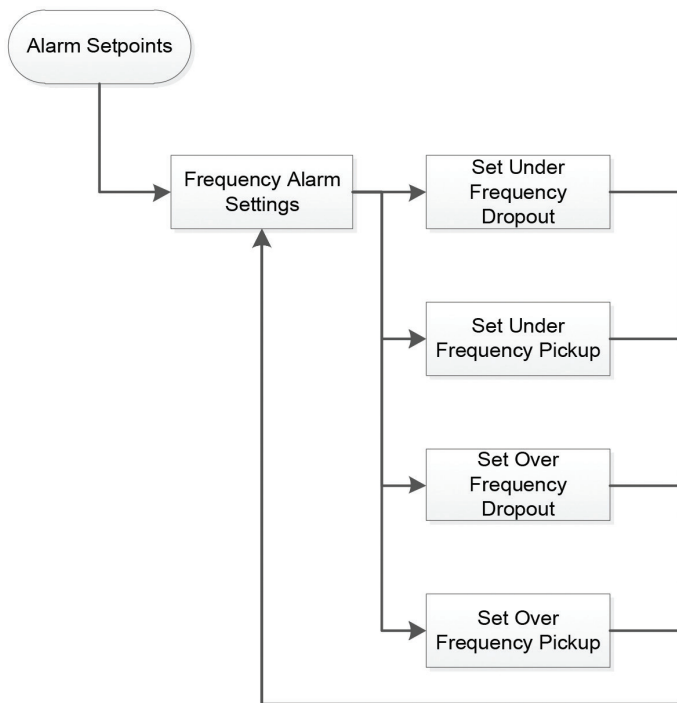

Note: Pressing the Back or Cancel button when available will return the screen to the previous option.

Appendix I (a): inputs / outputs tab menu structure

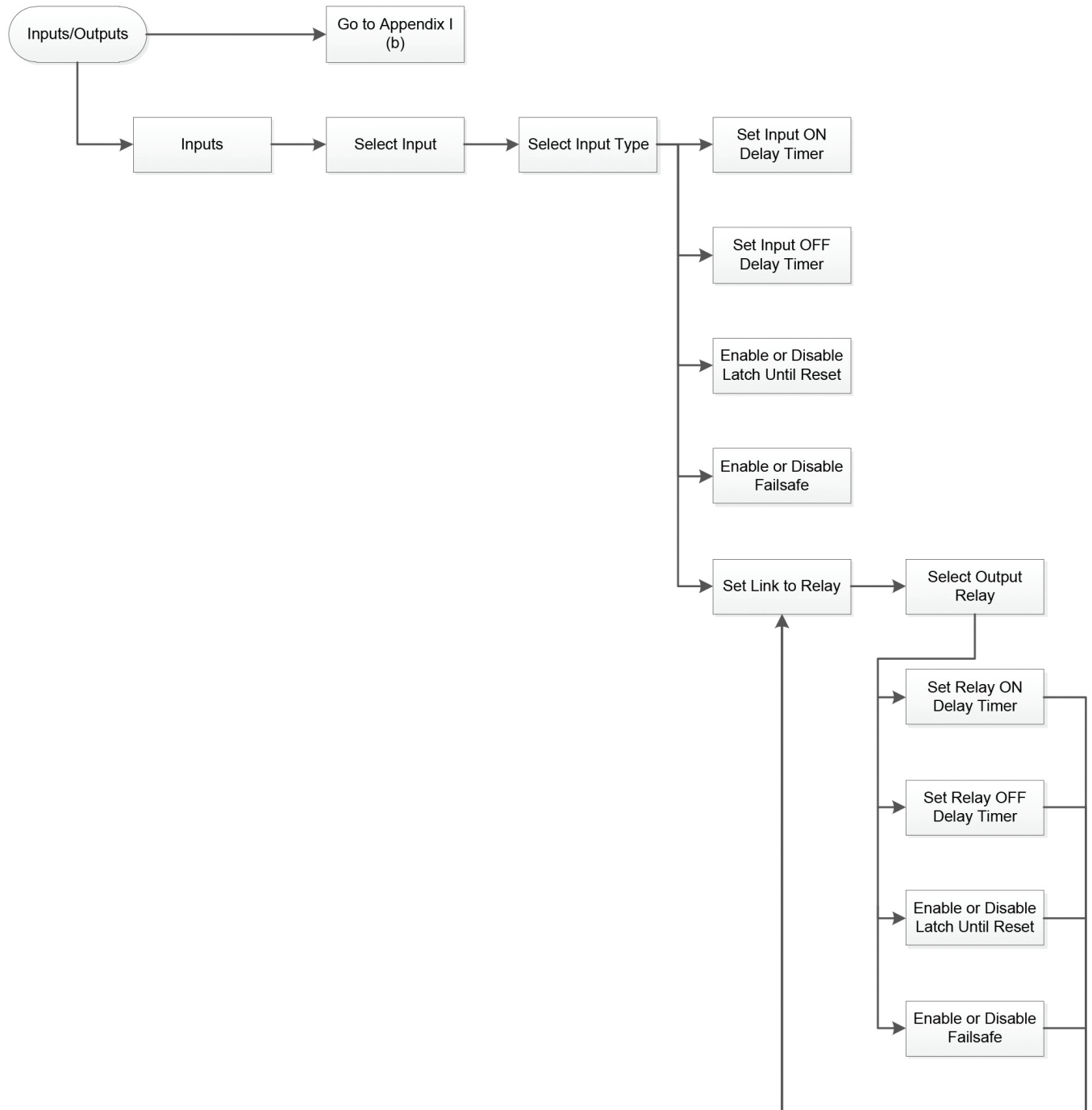

Note: Pressing the Back or Cancel button when available will return the screen to the previous option.

Appendix I (b): inputs / outputs tab menu structure continued

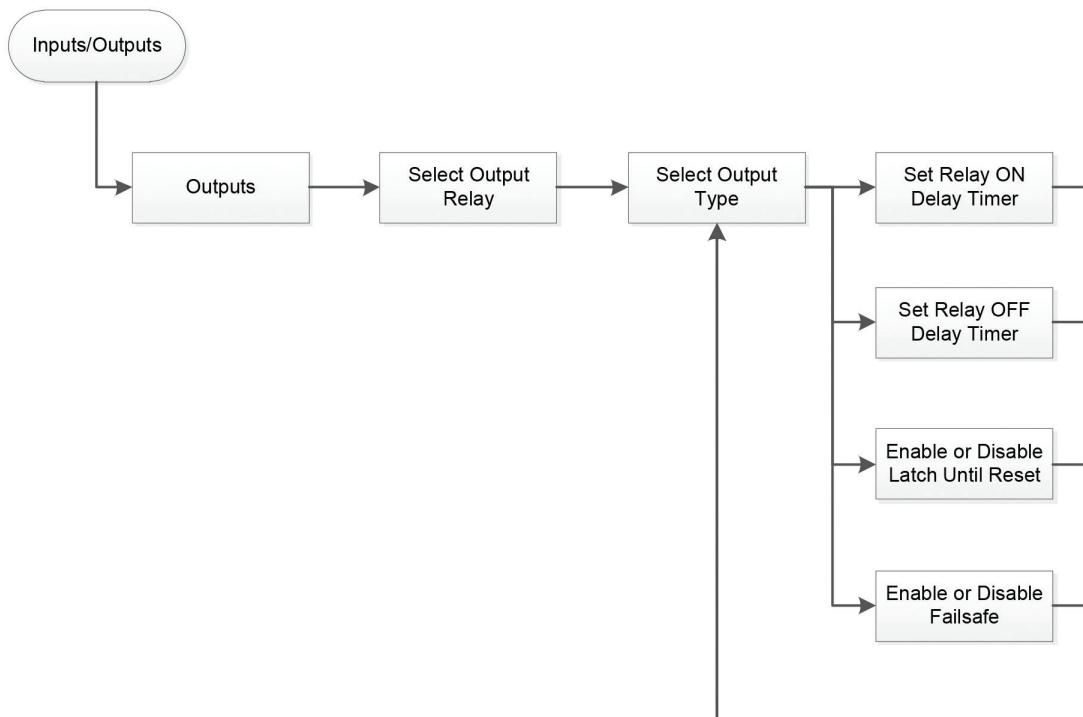

Note: Pressing the Back or Cancel button when available will return the screen to the previous option.

Appendix J: History stats diag. Tab menu structure

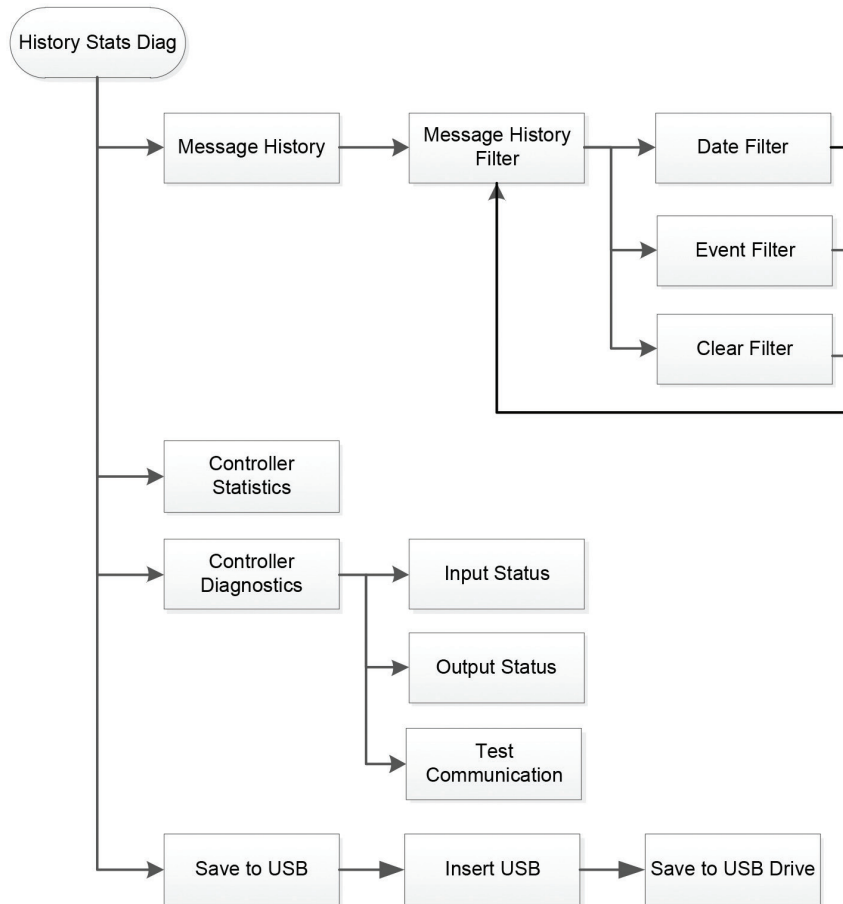

Note: Pressing the Back or Cancel button when available will return the screen to the previous option.

Appendix K: Relay option board– tab menu structure

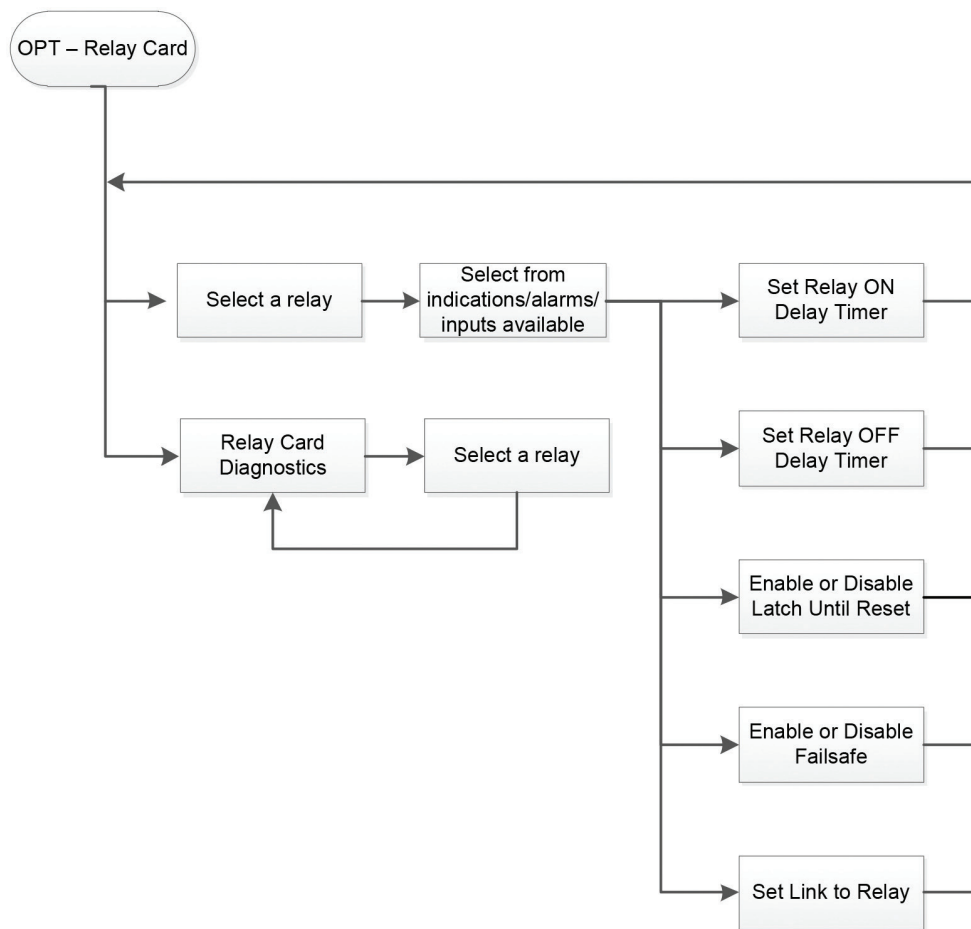

Note: Pressing the Back or Cancel button when available will return the screen to the previous option.

Appendix L (a): 4-20 mA device – tab menu structure

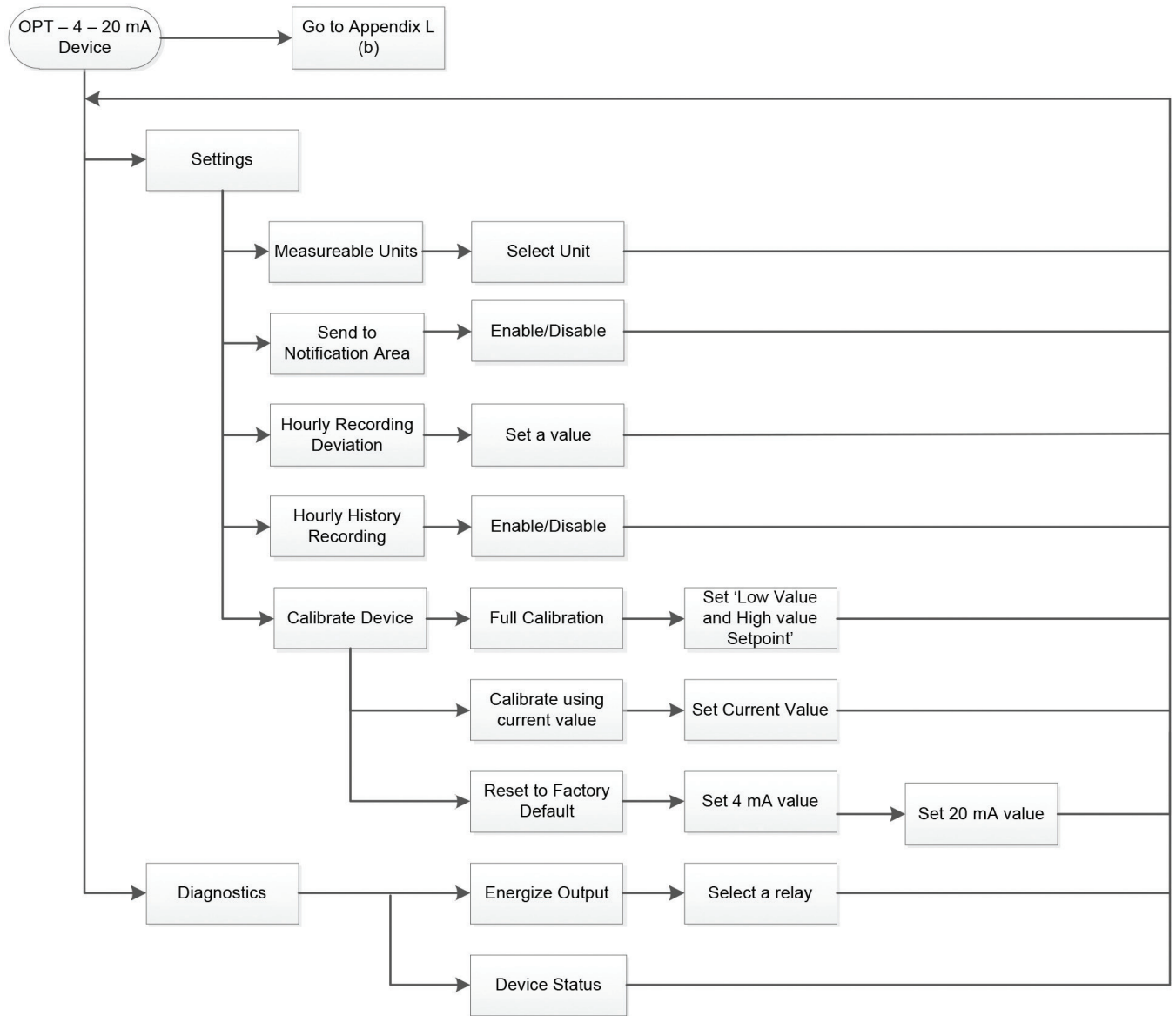

Note: Pressing the Back or Cancel button when available will return the screen to the previous option.

Appendix L (b): 4-20 mA device – tab menu structure continued

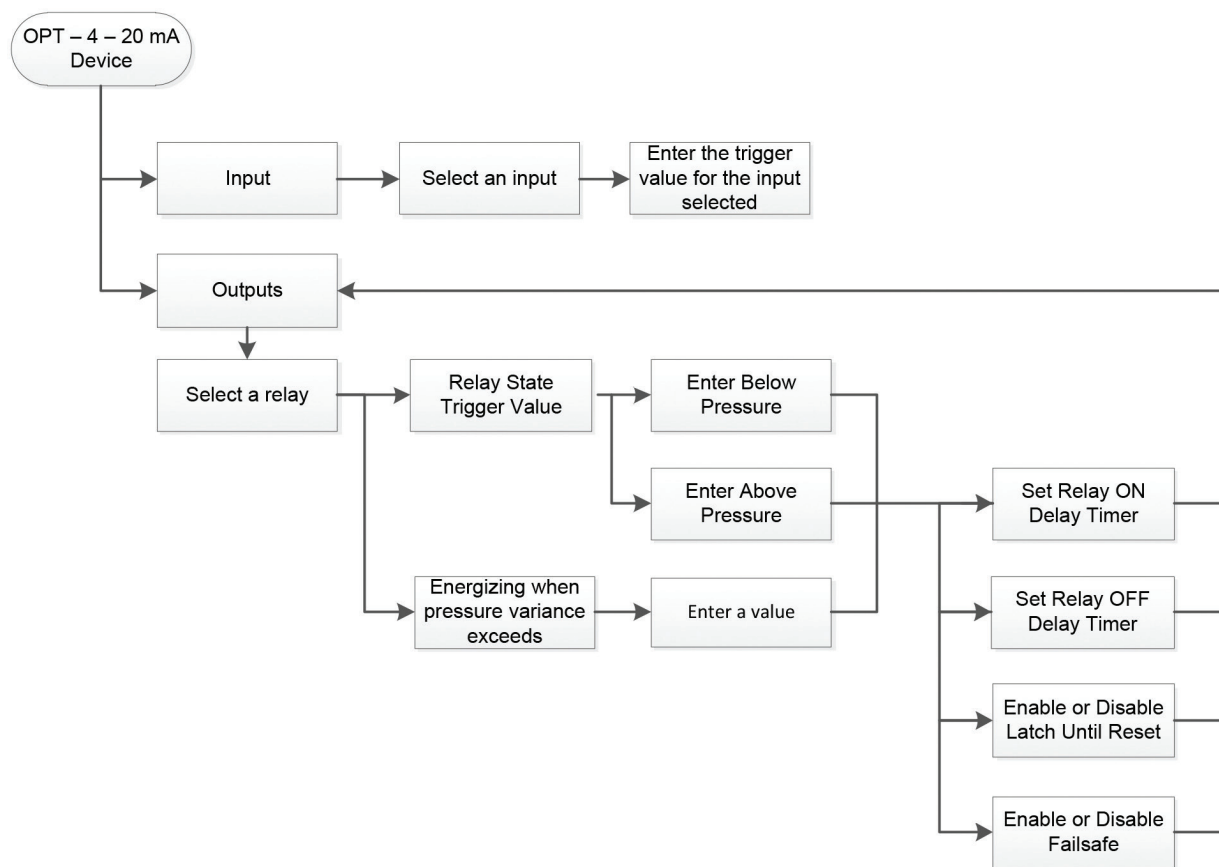

Note: Pressing the Back or Cancel button when available will return the screen to the previous option.

Appendix M: MODBUS board – tab menu structure

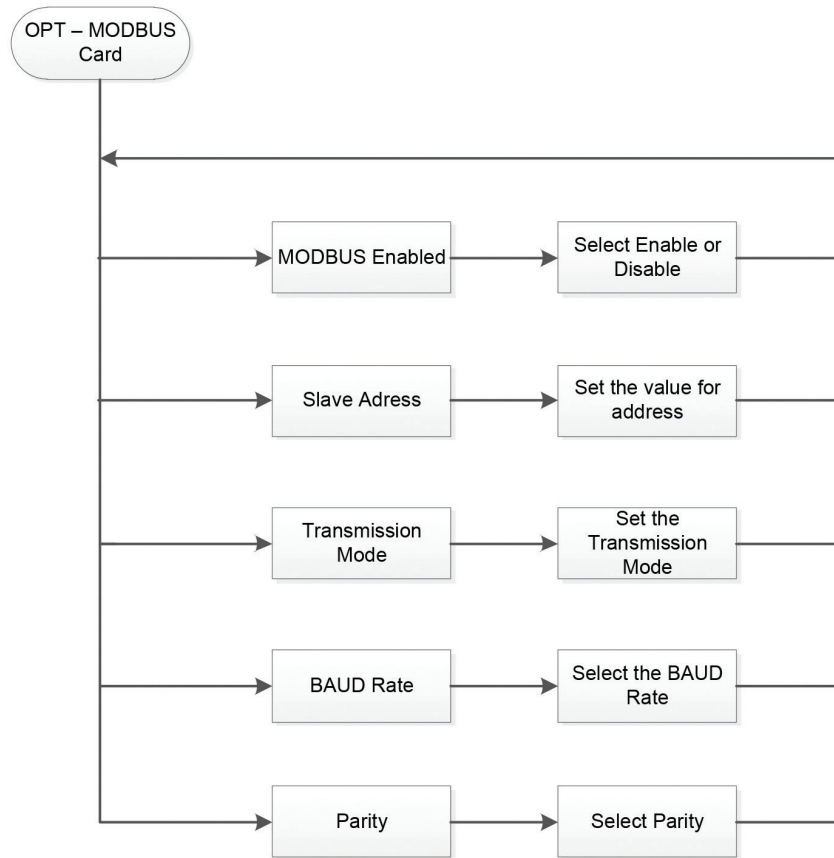

Note: Pressing the Back or Cancel button when available will return the screen to the previous option.

Appendix N: Supervisory alarm option board – tab menu structure

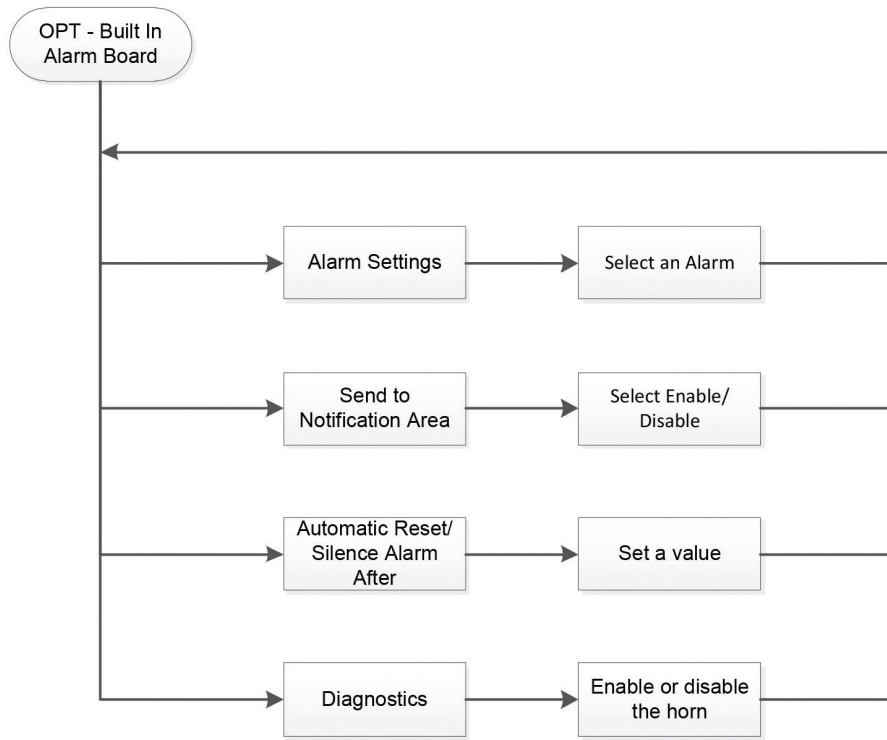

Note: Pressing the Back or Cancel button when available will return the screen to the previous option.

Appendix O: Alarm/Status messages

Message	Description
ATS CONNECTED TO S2	The automatic transfer switch is in the emergency position
ATS CONNECTED TO S1	The automatic transfer switch is in the normal position
DELUGE VALVE START	The controller started the motor after it received a deluge valve start signal
EMERGENCY START	The emergency start handle was pressed in and the motor started
FAIL TO START	There was a call to start the motor, however, the amperage draw did not reach 20% of the programmed motor full load amps
FAIL TO STOP	If the amperage draw has not dropped below 20% of the programmed motor full load amps two (2) seconds after a stop command, this alarm will be triggered
INTERLOCK	The interlock signal has been received
POWER ON	Notification will appear when the controller has power within the range of 200 – 600 VAC
PUMP RUNNING	The amperage draw on the motor has reached at least 20% of the programmed motor full load amps
LOCAL START	The start pushbutton on the enclosure flange was pressed initiating a start sequence
LOCAL STOP	The stop pushbutton on the enclosure flange was pressed initiating a stop sequence
BELOW START PRESSURE	The pump has started running because of a low-pressure condition
START ABOVE PRESSURE	The pump has started running because the pressure has exceeded the start above pressure set point
LOW PRESSURE ALARM	The system pressure is lower than the programmed low-pressure alarm set point
HIGH PRESSURE ALARM	The system pressure is above the programmed high-pressure alarm set point
REMOTE MANUAL START	The pump has started via a remote start signal
REMOTE MANUAL STOP	The pump has stopped via a remote stop signal
REMOTE AUTO START	The remote auto start signal has been received
HARDWARE FAULT	Controller detects a hardware fault in any of the three boards, ATS board, I/O board or logic board
TRANSDUCER FAILURE	The controller has detected that the transducer has failed
MOTOR OVERLOAD	The amperage draw has exceeded 125% of the programmed motor full load amps
LOW RESERVOIR	The controller has received a low reservoir signal
HIGH RESERVOIR	The controller has received a high reservoir signal
LOW ROOM TEMP	The controller has received a low room temperature signal
HIGH ROOM TEMP	The controller has received a high room temperature signal
LOW SUCTION	The controller has received a low suction signal
LOW FOAM LEVEL	The controller has received a low foam signal
LOAD SHED	The load shed timer has started timing and the load shed output has closed
INPUT 1	A signal from input 1 was received
INPUT 2	A signal from input 2 was received
INPUT 3	A signal from input 3 was received
INPUT 4	A signal from input 4 was received
INPUT 5	A signal from input 5 was received
INPUT 6	A signal from input 6 was received
INPUT 7	A signal from input 7 was received
INPUT 8	A signal from input 8 was received
INPUT 9	A signal from input 9 was received
INPUT 10	A signal from input 10 was received
LOCKED ROTOR TRIP	The controller has tripped on the built in locked rotor over current protection
AUTOMATIC SHUTDOWN	Automatic shutdown is enabled if the LED on the alarm is green
RUN PERIOD TIMER	The minimum time a motor will run for after a start from an automatic means
ACCELERATION TIMER	Delays energizing 2 CR relay for whatever it is connected for
SEQUENTIAL START TIMER	A start sequence has been started, however, it is delayed due to the programmed sequential start timer
LOW SUCTION RESET TIMER	Once the input for low suction clears, controller will start the timer and once elapsed will allow the restart of the motor if the starting condition exists
LOW FOAM RESET TIMER	Once the input for low foam clears, controller will start the timer and once elapsed will allow the restart of the motor if the starting condition exists
FAIL TO START TIMER	A timer has been started to detect 20% of the programmed motor full load amps after a call to start is initiated
FAIL TO STOP TIMER	A timer has been started to detect less than 20% of the programmed motor full load amps after a call to stop is initiated
TD S1 TO S2	Timer for the delay between transfer of transfer switch from S1 to S2

Appendix O: Alarm/Status messages

Message	Description
TD S2 TO S1	Timer for the delay between transfer of transfer switch from S1 to S1
TD IN NEUTRAL	When the automatic transfer switch is in the neutral position when both Source 1 and Source 2 are open, timer for delay to transfer from neutral to Source 1 or Source 2 when they become available
TD ENGINE START	Timer from delay in starting the engine when an engine start signal is received
TD S2 FAIL (TDS2F)	Call to start the start of generator is received, timer starts for the controller to detect a healthy voltage on the source 2
TD ENGINE COOLDOWN	A call to go back to normal source is received, timer starts for the delay to transfer back to normal to allow the engine cooldown
ENGINE TEST RUN	Appears when a call for an engine test run is initiated, controller is operating from Source 2, and at least 20% of the programmed motor full load amps is detected
ENGINE TEST FAIL	Appears when the controller is operating from Source 2, a call to start the engine is initiated, the test run timer expires and less than 20% of the programmed engine full load amps is detected
MOTOR TEST RUN	Appears when a call for a motor test run is initiated, and at least 20% of the programmed motor full load amps is detected
MOTOR TEST ABORT	Appears when the test run timer expires and less than 20% of the programmed motor full load amps is detected
ATS TRANSFER FAILURE	When a signal is received of transfer and the transfer switch cannot initiate a transfer
SOURCE 2 DISCONNECTED	Source two disconnect is switched off and there is not voltage present in source 2
S1 AVAILABLE	Controller has detected voltage in source 1
S2 AVAILABLE	Controller has detected voltage in source 2
S1 PHASE FAILURE	A phase failure is detected in source 1
S2 PHASE FAILURE	A phase failure is detected in source 2
S1 UNDER VOLTAGE	The voltage measured by the controller is lower than the programmed under voltage alarm set point for the normal source
S2 UNDER VOLTAGE	The voltage measured by the controller is lower than the programmed under voltage alarm set point for the emergency source
S1 OVER VOLTAGE	The voltage measured by the controller has exceeded the programmed over voltage alarm set point for the normal source
S2 OVER VOLTAGE	The voltage measured by the controller has exceeded the programmed over voltage alarm set point for the emergency source
S1 UNDER FREQUENCY	The frequency measured by the controller is lower than the programmed under frequency alarm set point for the normal source
S2 UNDER FREQUENCY	The frequency measured by the controller is lower than the programmed under frequency alarm set point for the emergency source
S1 OVER FREQUENCY	The frequency measured by the controller has exceeded the programmed over frequency alarm set point for the normal source
S2 OVER FREQUENCY	The frequency measured by the controller has exceeded the programmed over frequency alarm set point for the emergency source
S1 PHASE REVERSAL	The controller has detected a phase reversal on the system voltage of the normal source
S2 PHASE REVERSAL	The controller has detected a phase reversal on the system voltage of the emergency source
LOW SUCTION SHUTDOWN TIMER	When a signal for low suction is initiated, the timer starts, the timer starts and if the input does not clean before the timer is elapsed it shuts down the motor
LOW FOAM SHUTDOWN TIMER	When a signal for low foam is initiated, the timer starts and if the input does not clear before the timer is elapsed it shuts down the motor
LOW SUCTION SHUTDOWN	The controller has shut down because of low suction
LOW FOAM SHUTDOWN	The controller has shut down because of low levels of foam
REMOTE START/STOP	A remote start/stop input signal is received
PROOF PRESSURE SWITCH	A proof pressure switch input signal is received
ENABLE SEQUENTIAL START	The sequential start is programmed to be enabled in the controller
GO TO SOURCE 1	A go to source 1 input signal has been received
GO TO SOURCE 2	A go to source 2 input signal has been received
MOTOR TEST ABORTED	A call to abort the motor test is received by the controller and less than 20% of full load motor amps is detected by the controller
WAITING FOR S1	When the controller is in source 2, this indication shows as the controller is waiting for healthy voltage to appear in source 1 to initiate a transfer from source 2 to source 1
WAITING FOR S2	When a to start the engine is initiated, the controller is waiting for source 2 to have healthy voltage to initiate a transfer from source 1 to source 2

Appendix P: I/O board error codes

Code	Name	Description
P0	All is good	Everything is operating as expected
41	Communication Error	There is no communication received from the display board
42	Frequency Error	The frequency measurement is not receiving an accepted frequency (40-72Hz)
43	Zero Cross Error	The board did not receive an AC zero crossing on the Startup
44	PSU Error	One of the power supply voltages is out of spec. Voltages monitored are: 5V, 3.3V, 1.25V, -5V, 24V, 24V Drain Valve, 24V Opt Card
45	4-20mA Error	The 4-20mA current is below 3.8mA or above 20.2mA

Appendix Q: Power wire cable reference

Line terminals on main isolation switch (Incoming cables)						Qty. & Cable sizes	Service entrance GND. LUG QTY. & Cable sizes
Line voltage							
	200-208V	220-240V	*380-415V	440-480V	550-600V		
MAX HP	25	30	40	60	75	(1)#14-1/0 Per Ø (CU/AL)	(1)#14-2/0 (CU/AL)
	40	50	75	100	100	(1)#4-4/0 Per Ø (CU)	(1)#4-350MCM (CU/AL)
	75	75	150	200	200	(1)#3-350MCM Per Ø (CU/AL)	(1)#4-350MCM (CU/AL)
	100	125	200	250	300	(2)3/0-250MCM Per Ø (CU/AL)	(2)1/0-750MCM (CU/AL)
	150	200	300	400	400	(2)250-350MCM Per Ø (CU/AL)	(2)1/0-750MCM (CU/AL)
	200	-	350	450	550	(2)#1-500MCM PER Ø (CU/AL)	(2)1/0-750MCM (CU/AL)
	250	300	500	600	700	(3)3/0-400MCM PER Ø (CU/AL)	(2)1/0-750MCM (CU/AL)

*Coils available: 380V-50Hz, 380V-60Hz, 415V-50Hz, 415V-60Hz

*For proper cable size, refer to the National Electrical Code NFPA-70



Eaton
Eaton Canadian Operations
5050 Mainway
Burlington, ON L7L 5Z1
Email: chcfirepump@eaton.com
Web: www.chfire.com

© 2019 Eaton
All Rights Reserved
Printed in USA
Publication No. MN124016EN
August 2019

Eaton is a registered trademark.

All trademarks are property
of their respective owners.